



CMR COLLEGE OF ENGINEERING & TECHNOLOGY (AUTONOMOUS)

NAAC Accredited Institution with 'A' Grade
Kandlakoya (V), Medchal Road, Hyderabad -501401.

CMRCET/PRIN/SPORTS/AY2017-18/01

Date: 29/04/2017

OFFICE ORDER

The following is the composition of committee under Sports & Games Committee for the academic year 2017-18. It is designed to serve the interests of the student community in competitive sports and other recreational activities (Both Indoor and Outdoor).

The composition of Sports & Games Committee is as follows:

S.No	Name of the member	Designation	Position
1.	Major Dr. V. A. Narayana	Principal	Chairman
2.	Mr. Syed Rafeeq	Physical Director	Convener
3	Mr. B. Dharma Teja	Assistant Professor	Member
4	Mr. Md. Sirajuddin	Assistant Professor	Member
5	Mr. S. Anil	Assistant Professor	Member
6	Mr. G. Saidulu	Assistant Professor	Member
7	Mr. G. Rajanand	Assistant Professor	Member
8	Mr. V. Harish	Assistant Professor	Member
9	Ms. N Snehitha	Assistant Professor	Member
10	Mohd. Akheel Ahmed	Student	Member
11	P. Vivek	Student	Member
12	M. Ajith Kumar	Student	Member
13	M. Srinath	Student	Member
14	L. Harshini	Student	Member

Convener
Sports & Games Committee

Principal

Copy Submitted to: (1) The Secretary Garu – For your kind information Pl.

Copy to:

1. IQAC Coordinator
2. Controller of Examinations
3. All HODS
4. Administrative Officer
5. Accounts Officer
6. Concerned Faculty
7. Students Notice Board



CMR COLLEGE OF ENGINEERING & TECHNOLOGY
(AUTONOMOUS)

NAAC Accredited Institution with 'A' Grade
Kandlakoya (V), Medchal Road, Hyderabad -501401.

CMRCET/PRIN/SPORTS/AY2017-18/CIR-01

Date: 06/05/2017

CIRCULAR

All the members of Sports & Games committee of the college are hereby informed that, the sports & Games committee meeting is scheduled on 09.05.2017 & the Venue will be the Department of Physical Education at 3.00pm. All are requested to be present on time.

The Agenda of the meeting is:

- i) Review meeting on old events organized
- ii) Sports calendar to plan for the current Academic year & to conduct all sports month wise.
- iii) For scheduling all the related activities without affecting the class/lab work, examination Schedules.
- iv) Train students for inter college, inter university and National level.
- v) To organize competitions of intra murals, extra murals, Fresher day and Annual Day.

Convener
Sports & Games Committee

Principal

Copy Submitted to: (1)The Secretary Garu – For your kind information Pl.

Copy to:

1. IQAC Coordinator
2. Controller of Examinations
3. All HODS
4. Administrative Officer
5. Accounts Officer
6. Concerned Faculty
7. Students Notice Board



CMR COLLEGE OF ENGINEERING & TECHNOLOGY

(AUTONOMOUS)

NAAC Accredited Institution with 'A' Grade

Kandlakoya (V), Medchal Road, Hyderabad -501401.

SPORTS & GAMES COMMITTEE MINUTES OF MEETING

1. The Meeting was held on 9th May 2017 from 3.00 to 4:00 pm in the Department of Physical Education.
2. The Convener welcomed all the committee members & started the meeting with congratulating them for the smooth conduction of last year Programs in all the events took place.
3. SOP with Objectives, Roles & responsibilities are agreed as per the previous year.
4. Discussed about the Sports events to be conducted for the students for the Academic Year and prepared a Sports calendar. From July month itself planned and decided the program.
July: Elite Football Cup
August: CMRCET Volley ball Super League
Sept: CMR Pro Kabaddi League & 4th TSIEC Football Tournament
Oct: Engineer's Throw Ball & Indoor Games Tournament
Dec: Engineering Cricket & Basket ball League
Jan: Hidden Talent Search in Freshers 2018
Feb: Ultimate Kho Kho League
March: Annual Day Sports.
5. The committee has already discussed in the Agenda 3 that, monthly wise matches to be conducted, and keeping in view on Academic Calendar, should plan the events; preferably decided to have matches on Saturday and if required on Sundays.
6. Organizing Competitions:
 - a) Intra murals as per the sports calendar Fresher's day should be in the month of December
 - b) Extra murals TSIEC Foot Ball in the month of September
 - c) Annual Day matches during March/April.

The List Sports Committee members attended the meeting:

S.No	Name of the member	Designation	Position	Signature
1.	Major Dr. V. A. Narayana	Principal	Chairman	
2.	Mr. Syed Rafeeq	Physical Director	Convener	
3	Mr. B. Dharma Teja	Assistant Professor	Member	
4	Mr. Md. Sirajuddin	Assistant Professor	Member	
5	Mr. S. Anil	Assistant Professor	Member	
6	Mr. G. Saidulu	Assistant Professor	Member	
7	Mr. G. Rajanand	Assistant Professor	Member	
8	Mr. V. Harish	Assistant Professor	Member	
9	Ms. N Snehitha	Assistant Professor	Member	
10	Mohd. Akheel Ahmed	Student	Member	
11	P. Vivek	Student	Member	
12	M. Ajith Kumar	Student	Member	
13	M. Srinath	Student	Member	
14	L. Harshini	Student	Member	

Convener
Sports & Games Committee

Principal



CMR COLLEGE OF ENGINEERING & TECHNOLOGY

(AUTONOMOUS)

NAAC Accredited Institution with 'A' Grade

Kandlakoya (V), Medchal Road, Hyderabad -501401.

Date: 19.05.2017

To,
IQAC Coordinator
CMRCET

Sub: Requesting approval to organize different sports events under Sports & Games Committee in the A.Y:2017-18 – Reg.

Respected Sir,

As you are aware that, the Sports & Games Committee will organize different sports events for our students every year, right from the beginning of the Academic year, with prior permission, herewith I am submitting the proposed list of Intramural & Extramural Tournaments for the A.Y: 2017-18.

Hence I request you to kindly permit to organize the said event tournaments.

The Events are as follows:

1. July: Elite Football Cup
2. August: CMRCET Volley ball Super League
3. Sept: CMR Pro Kabaddi & 4th TSIEC Football Tournament
4. Oct: Engineer's Throw Ball & Indoor Games Tournament
5. Dec: Engineering Cricket & Basket ball League
6. Jan: Hidden talent search in Freshers 2018
7. Feb: Ultimate Kho Kho League
8. March: Annual Day Sports.

The tentative schedule of the events is as enclosed

For the smooth conduction of tournaments I request you to sanction the approximate budget amount of Rs.5, 64, 598/-

Thanking you,

Convener
Sports & Games Committee



CMR COLLEGE OF ENGINEERING & TECHNOLOGY

(AUTONOMOUS)

NAAC Accredited Institution with 'A' Grade
Kandlakoya (V), Medchal Road, Hyderabad -501401.

SPORTS & GAMES COMMITTEE

Strategic Perspective Plan for the Academic Year 2017-18

Sl. No.	Date of the Event	Name of the Event	Budget for the event (Rs)	Details
1	8 th , 15 th & 22 nd of July, 2017	Elite Football Cup	NIL	Intramurals Football matches conducted for students
2	12 th , 19 th & 26 th of August, 2017	CMRCET Volley ball Super League	NIL	Intramurals Volley ball matches conducted for Boys
3	9 th & 16 th of September 2017	CMR Pro Kabaddi League	NIL	Intramurals Kabaddi matches conducted for students.
3	22 nd to 24 th September, 2017	4 th TSIEC Football Tournament	1,57,400	Organized Telangana state Inter Engineering Collegiate Football Tournament
4	7 th , 14 th , & 21 st , 28 th of October 2017	Engineer's Throw ball & Indoor Games Tournament	NIL	Intramurals Throw ball & Indoor Games events conducted for students
5	9 th , 16 th & 23 rd , 30 th of December, 2017	Engineering Cricket & Basket ball League	NIL	Intramurals Cricket & Basket ball matches conducted for students
6	10 th to 12 th of January 2018	Hidden talent search for Freshers 2018	60,711	Conducted Intramurals for Freshers in all Sports & Games events
7	10 th , 17 th & 24 th of February 2018	Ultimate Kho Kho League	NIL	Intramurals Kho Kho matches conducted for students
8	26 th March 2018 onwards	Annual Day Sports	2,31,500	Conducted Annual Sports for all the students of various streams in all Sports & Games events for Sports Day



CMR COLLEGE OF ENGINEERING & TECHNOLOGY

(AUTONOMOUS)

NAAC Accredited Institution with 'A' Grade

Kandlakoya (V), Medchal Road, Hyderabad -501401.

Sports & Games Committee - Strategy Document

1. Sports & Games Committee meeting is conducted at the beginning of each academic year.
2. A brief synopsis is given by the committee on the importance of committee.
3. Students are registered for committee.
4. Students are encouraged to actively participate in the Sports activities.
5. Sports & Games Committee has given instructions and suggestions to the students about implementation of the Sports events.

IQAC Coordinator

Principal



CMR COLLEGE OF ENGINEERING & TECHNOLOGY

(AUTONOMOUS)

NAAC Accredited Institution with 'A' Grade

Kandlakoya (V), Medchal Road, Hyderabad -501401.

03/07/2017

To
The Principal
CMRCET

Through: IQAC Coordinator

Sub: Permission to organize Elite Football Cup Req. – Reg.

Respected Sir,

As per the approval from the IQAC for the sports events proposed to be conducted in the A.Y: 2017-18, the Sports & Games Committee will organize Elite Football Cup on every Saturday of July. I request your kind approval to conduct the event.

- Dates of the Events: 8th, 15th and 22nd of July, 2017
- Name of the Event: Elite Football Cup
- Importance: To bring out their hidden talents & to train them further
To select them for college team, other university & National level
- Venue: CMRCET Football Ground.
- Target Audience: Students of respective department.
- Resources required: Play fields & playing Equipment.

Faculty members who are involved in the sports committee will be taking care of their respective department match and also the student members of the sports club will help the smooth conduct of the event.

Thanking you sir,

Recommended

Arcon
Coordinator
Internal Quality Assurance Cell
CMR College of Engineering & Technology
Kandlakoya (V), Medchal Road,
Hyderabad - 501 401.

Convener
Sports & Games Committee

Printed



CMR COLLEGE OF ENGINEERING & TECHNOLOGY
(AUTONOMOUS)

NAAC Accredited Institution with 'A' Grade
Kandlakoya (V), Medchal Road, Hyderabad -501401.

CMRCET/PRIN/ SPORTS/AY2017-18/CIR-02

Date: 05/07/2017

Sports & Games Circular

All the students are here by informed that, the Elite Football Cup was scheduled in the month of July 2017 on every Saturday. In this regards all the departmental Football teams should give their team entry by filling the entry form.

The following are the maximum number of players allowed from each department for the respective game mentioned below:

E V E N T S:

FOOTBALL

15 Players (11+4)

- a) Department team must submit the eligibility form of their players duly signed by HOD and sports in-charge of the respective department, the in-charge of particular department, must be present when their dept, team is playing the match without fail.
- b) All the entries should be sent to the Physical Director CMRCET by 6th July, 2017 before 2.00pm without fail. The fixtures and matches schedules will be displayed on notice board and circulated in all the sports groups on 7th July, 2017.
- c) All the matches will be on knock out basis.
- d) Sports /Discipline committee/Physical Director have right to disqualify any team or game in any circumstances.
- e) All the players must come in proper dress, i.e., SHORT & T.SHIRT only. Those players will be allowed for the matches.
- f) The matches will held only on Saturdays.

Convener

Sports & Games Committee

Principal

Copy submitted to Secretary Garu for kind information

Copy to

- 1) HODs to kindly educate the students on the above and send the lists please
- 2) A.O
- 3) Sports Committee members
- 4) To be read in the class room
- 5) Notice Board.

ELITE FOOTBALL CUP 2017

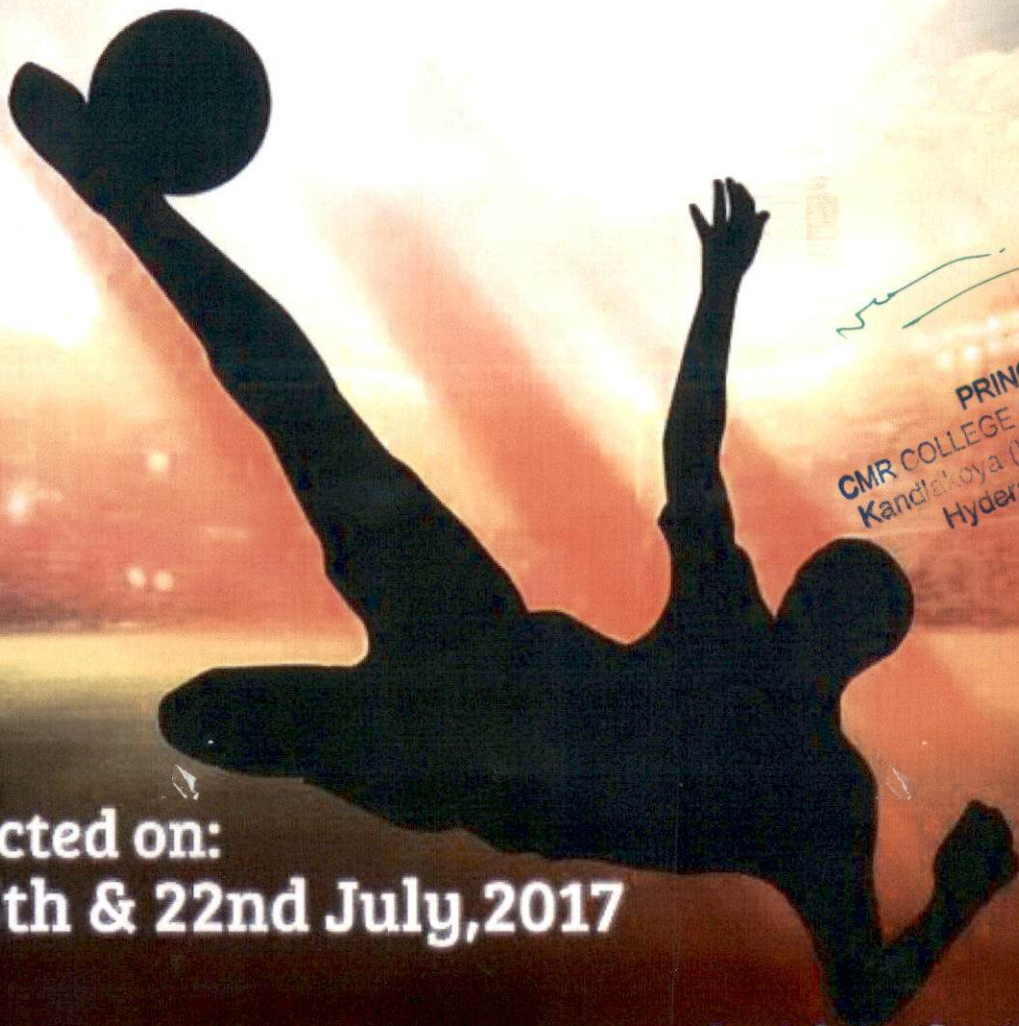

PRINCIPAL
CMR COLLEGE OF ENGG. & TECH.
Kandlakoya (V), Medchal Road,
Hyderabad-501401.

Conducted on:
8th, 15th & 22nd July, 2017

Last date of registration:
6 July 2017

CMR COLLEGE OF ENGINEERING AND TECHNOLOGY
KANDLAKOYA, MEDCHAL, HYDERABAD-501401





CMR COLLEGE OF ENGINEERING & TECHNOLOGY

(AUTONOMOUS)

NAAC Accredited Institution with 'A' Grade
Kandlakoya (V), Medchal Road, Hyderabad -501401.

Date: 05.07.2017

To,
Smt.ChVasantha Latha
Secretary & Correspondent
CMR Technical Campus.

Sir,

Sub: Request to be Chief Guest of Elite Football Cup- Reg.

CMR College of Engineering & Technology is Organizing Elite Football Cup on 8th, 15th, 22nd July, 2017. It would be our great honor if you would grace the occasion as Chief Guest for the Elite Football Cup on 8th July 2017 at 9:30 AM.

Thank you,

Major Dr. V.A. Narayana
Principal

PRINCIPAL
CMR COLLEGE OF ENGG. & TECH.
Kandlakoya (V), Medchal Road,
Hyderabad-501401.

DEPARTMENT O.
PHYSICAL EDUCATION

Cordially Invites Your Gracious Presence
On The Occasion Of

**ELITE
FOOTBALL
CUP**

INAUGURAL FUNCTION

On
8TH July, 2017 at 10:00 AM

Chief Guest

Smt.Ch.Vasantha latha reddy
Secretary & Correspondent,CMRTC

Venue: CMR Grounds

PRINCIPAL
CMR COLLEGE OF ENGG. & TECH.
Kandlakoya (V), Medchal Road,
Hyderabad-501401.

Programme Schedule

- 10:00 AM – INVITING THE GUESTS ON THE DAIS
- 10:05 AM – FLAG HOISTING
- 10:10 AM – VISITING TEAMS
- 10:15 AM – OATH TAKING
- 10:20 AM – ADDRESS BY MAJOR DR. V A NARAYANA ,
PRINCIPAL, CMRCET
- 10:25 AM – ADDRESS BY DR. M. JANGA REDDY,
PRINCIPAL, CMRIT
- 10:30 AM – ADDRESS BY DR. ABBULU , PRINCIPAL,
CMRCP
- 10:40 AM – ADDRESS BY SRI CH. SRISAILAM REDDY,
SECRETARY & CORRESPONDENT, CMREC
- 10:50 AM – ADDRESS BY SRI CH. BHOOPAL REDDY,
VICE CHAIRMAN, CMREC
- 10:55 AM – ADDRESS BY SRI CH. GOPAL REDDY,
SECRETARY & CORRESPONDENT,
CMRGI
- 11:05 AM – ADDRESS BY CHIEF GUEST,
SMT.CH.VASANTHA LATHA REDDY
SECRETARY & CORRESPONDENT,CMRTC
- 11:10 AM – DECLARING THE MEET OPEN
- 11:15 AM – VOTE OF THANKS

Event Photos: Elite Football Cup



PRINCIPAL
CMR COLLEGE OF ENGG. & TECH.
Kandlakurta (M), Medchal Road,
Hyderabad-501401.

Event Report: Elite Football Cup in the month of July 2017,

- Request letter to principal to organize the Elite Football Cup through IQAC Coordinator.
- Got the approval from Principal to organize the Elite Football Cup during the month of July, and the matches were only on Saturdays.
- Circular Issued to students for the Elite Football Cup and asked for entries.
- There were 6 teams who registered for this event.
- The Draws have been taken out in the presence of 3 committee members and the captains of various teams. Draws were like this,
 - i) CSE v/s MBA winner of these two teams played with ECE, ECE team has got bye.
 - ii) In the second half EEE v/s CIVIL winner of these two played with MECH, MECH team has got bye.
 - iii) Finally the result was MECH winners and ECE runners up.
- The chief Guest for this event was smt. Vasantha Latha Reddy secretary & correspondent, CMRTC
- The Football matches conducted for boys only.
- It is very much required for students to have physical activity once in a week. Students' involvement in academics is limited to writing Mid Exams/Labs etc. in the week end there must be a recreation/any physical activity to come out with stress in the end of the week.
- And also in the week end the other students too enjoyed a lot by encouraging their department team. They also got relaxed after a week stress.
- The matches were conducted in the main grounds of CMRCET.
- The resources from the college were only play fields & playing equipment.
- 8 students from Sports Club were involved in the event they made it success, and also the faculty of various departments was present when and where their department team is playing without any disturbance the event was completed.
- Closing ceremony, Prize distribution was held on 22nd July, 2017 the chief guest for the function was Sri Ch .Gopal Reddy Chairman CMRTC.

Outcomes:

During these matches few students who are good at Foot ball game skills got selected for further training and they can be sent for college team, other university & National level

Thanking you sir

Convener
Sports & Games Committee



CMR COLLEGE OF ENGINEERING & TECHNOLOGY

(AUTONOMOUS)

NAAC Accredited Institution with 'A' Grade

Kandlakoya (V), Medchal Road, Hyderabad -501401.

01.08.2017

To
The Principal
CMRCET

Through: IQAC Coordinator

Sub: Permission to organize CMRCET Volley ball Super League Req. – Reg.

Respected Sir,

As per the approval from the IQAC for the sports events proposed to be conducted in the A.Y: 2017-18, the Sports & Games Committee will organize CMRCET Volley ball Super League in the month of August 2017, on every Saturday. I request your kind approval to conduct the event.

- Dates of the Events: 12th, 19th and 26th of August, 2017.
- Name of the Events CMRCET Volley ball Super League.
- Importance: To bring out their hidden talents & to train them further.
To select them for college team, other university & National level events.
- Venue: CMRCET Volley ball court.
- Target Audience: Students of respective department.
- Resources required: Play field & Playing Equipments.

Faculty members who are involved in the sports committee will be taking care of their respective department matches and also the student members of the sports club will help the smooth conduction of the event.

Thanking you sir,

Recommended
ACOM

Coordinator
Internal Quality Assurance Cell
CMR College of Engineering & Technology
Kandlakoya (V), Medchal Road,
Hyderabad - 501 401.

Convener
Sports & Games Committee



CMR COLLEGE OF ENGINEERING & TECHNOLOGY

(AUTONOMOUS)

NAAC Accredited Institution with 'A' Grade

Kandlakoya (V), Medchal Road, Hyderabad -501401.

CMRCET/PRIN/ SPORTS/AY2017-18/CIR-03

Date: 03/08/2017

Sports & Games Circular

All the students are hereby informed that, the CMRCET Volley ball Super League are scheduled in the month of August 2017 on all Saturdays. In this regard all the departmental teams should give their team entry by filling the entry form.

The following are the maximum number of players allowed from each department for the respective game mentioned below:

E V E N T:

VOLLEY BALL

10 Players (6+4)

- Department team must submit the eligibility form of their players duly signed by HOD and sports in-charge of the respective department. The in-charge of particular department must be present when their dept, team is playing the match without fail.
- All the entries should be sent to the Physical Director CMRCET by 5th August, 2017 before 2.00pm without fail. The fixtures and matches schedules will be displayed on notice board and circulated in all the sports groups on 7th August, 2017.
- All the matches will be on knock out basis.
- Sports /Discipline committee/Physical Director have right to disqualify any team or game in any circumstances.
- All the players must come in proper dress, i.e., SHORT & T.SHIRT only. Those players will be allowed for the matches.
- The matches will held only on Saturdays.

Convener

Sports & Games Committee

Copy submitted to Secretary Garu for kind information

Copy to

- 1) HODs to kindly educate the students on the above and send the lists please
- 2) A.O
- 3) Sports Committee members
- 4) To be read in the class room
- 5) Notice Board.

Principal

CMR COLLEGE OF ENGINEERING AND TECHNOLOGY

KANDLAKOYA, MEDCHAL, HYDERABAD-501401



CMRCET VOLLEY BALL SUPER LEAGUE

**LAST DATE FOR
REGISTRATIONS: 5TH
AUGUST, 2017**

**12TH, 19TH & 26TH
OF AUGUST, 2017**



PRINCIPAL
CMR COLLEGE OF ENGG & TECH.
Kandlakoya (V), Medchal Road,
Hyderabad-501401.



CMR COLLEGE OF ENGINEERING & TECHNOLOGY

(AUTONOMOUS)

NAAC Accredited Institution with 'A' Grade
Kandlakoya (V), Medchal Road, Hyderabad -501401.

Date: 05.08.2017

To,
Sri.Ch. Gopal Reddy
Chairman
CMR Technical Campus.

Sir,

Sub: Request to be Chief Guest of CMRCET Volley ball Super League - Reg.

CMR College of Engineering & Technology is Organizing CMRCET Volley ball Super League on 12th, 19th, 26nd August, 2017. It would be our great honor if you would grace the occasion as Chief Guest for the CMRCET Volley ball Super League on 12th August 2017 at 9:30 AM.

Thank you,

Major Dr. V.A. Narayana
Principal

PRINCIPAL
CMR COLLEGE OF ENGG. & TECH.
Kandlakoya (V), Medchal Road,
Hyderabad-501401.

DEPARTMENT C.
PHYSICAL EDUCATION

Cordially Invites Your Gracious Presence
On The Occasion Of

**CMRCET Volley ball Super
League**

INAUGURAL FUNCTION

On
12TH August, 2017 at 10:00 AM

Chief Guest
SRI.CH. GOPAL REDDY

CHAIRMAN ,CMR TECHNICAL CAMPUS.

Venue: CMR Grounds

JAGANNATH
PRINCIPAL
CMR COLLEGE OF ENGG. & TECH.
Kandlakoya (M), Medchal Road,
Hyderabad-501401.

Programme Schedule

- 10:00 AM – INVITING THE GUESTS ON THE DAIS
- 10:05 AM – FLAG HOISTING
- 10:10 AM – VISITING TEAMS
- 10:15 AM – OATH TAKING
- 10:20 AM – ADDRESS BY MAJOR DR. V A NARAYANA ,
PRINCIPAL, CMRCET
- 10:25 AM – ADDRESS BY DR. M. JANGA REDDY,
PRINCIPAL, CMRIT
- 10:30 AM – ADDRESS BY DR. ABBULU , PRINCIPAL,
CMRCP
- 10:40 AM – ADDRESS BY SRI CH. SRISAILAM REDDY,
SECRETARY & CORRESPONDENT, CMREC
- 10:50 AM – ADDRESS BY SRI CH. BHOOPAL REDDY,
VICE CHAIRMAN, CMREC
- 10:55 AM – ADDRESS BY SRI CH. GOPAL REDDY,
SECRETARY & CORRESPONDENT,
CMRGI
- 11:05 AM – ADDRESS BY CHIEF GUEST,
SRI.CH. GOPAL REDDY
CHAIRMAN ,CMR TECHNICAL CAMPUS.
- 11:10 AM – DECLARING THE MEET OPEN
- 11:15 AM – VOTE OF THANKS

Event Photos: CMRCET Volley ball Super League



PRINCIPAL
CMR COLLEGE OF ENGG. & TECH.
Kandlakota (V), Medchal Road,
Hyderabad-501401.

Event Report: CMRCET Volley ball Super League in the month of August 2017,

- Request letter to principal to organize the CMRCET Volley ball Super League through IQAC Coordinator.
- Got the approval from Principal to organize the CMRCET Volley ball Super League during the month of August, and the matches were only on Saturdays.
- Circular Issued to students for the CMRCET Volley ball Super League and asked for entries.
- There were 6 teams who registered for this event.
- The Draws have been taken out in the presence of 3 committee members and the captains of various teams. Draws were like this,
 - i) MECH v/s CSE winner of these two teams played with ECE, ECE team has got bye.
 - ii) In the second half EEE v/s MBA winner of these two played with CIVIL, CIVIL team has got bye.
 - iii) Finally the result was CSE winners and MBA runners up.
- The Volleyball matches conducted for boys only.
- It is very much required for students to have physical activity once in a week. The students' involvement in academics is more like MID Exam's /Labs etc. During the week end, there must be a recreation/any physical activity to have physical relaxation.
- And also in the weekend the other students too have enjoyed a lot by encouraging their department team. They also got relaxed after a week of stress.
- The matches were conducted in the Volleyball Courts of CMRCET.
- The resources from the college were only play fields & playing equipment.
- 8 students from Sports Club were involved in the event and they helped to make it successful. The faculty of various departments was also present when their department team is playing. The event was completed without any hitches.

Outcomes:

During these matches few students who are good at Volley ball game skills got selected for further training and they can be sent for college team, other university and National level

Thanking you sir

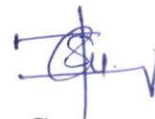

**Convener
Sports & Games Committee**



CMR COLLEGE OF ENGINEERING & TECHNOLOGY

(AUTONOMOUS)

NAAC Accredited Institution with 'A' Grade
Kandlakoya (V), Medchal Road, Hyderabad -501401.

28.08.2017

To
The Principal
CMRCET

Through: IQAC Coordinator

Sub: Permission to organize CMR Pro Kabaddi League Req. – Reg.

Respected Sir,

As per the approval from the IQAC for the sports events proposed to be conducted in the A.Y: 2017-18, the Sports & Games Committee will organize CMR Pro Kabaddi League in the first two weeks of September 2017 (only on Saturdays). I request your kind approval for the Conduct of the event.

- Dates of the Events: 9th & 16th of September, 2017.
- Name of the Event: CMR Pro Kabaddi League
- Importance: To bring out their hidden talents & to train them further.
To select them for college team, other university and national level.
- Venue: CMRCET Kabaddi Court.
- Target Audience: Students of respective department.
- Resources required: Play fields & playing Equipment.

Faculty members who are involved in the sports committee will be taking care of their respective department match and also the student members of the sports club will help the smooth conduction of the event.

Thanking you sir,

Recommended

ACOM

Coordinator
Internal Quality Assurance Cell
CMR College of Engineering & Technology
Kandlakoya (V), Medchal Road,
Hyderabad - 501 401.

Convener
Sports & Games Committee

Approved

[Handwritten signature]



CMR COLLEGE OF ENGINEERING & TECHNOLOGY

(AUTONOMOUS)

NAAC Accredited Institution with 'A' Grade
Kandlakoya (V), Medchal Road, Hyderabad -501401.

CMRCET/PRIN/ SPORTS/AY2017-18/CIR-04

Date: 01/09/2017

Sports & Games Circular

All the students are here by informed that, the CMR Pro Kabaddi League are scheduled on first two Saturdays in the month of September 2017. In this regard all the departmental Kabaddi teams should give their team entry by filling the entry form.

The following are the maximum number of players allowed from each department for the respective game mentioned below:

E V E N T:

KABADDI

12 Players (7+5)

- Department teams must submit the eligibility form of their players duly signed by HOD and sports in-charge of the respective department. The in-charge of particular department must be present when their department team is playing the match without fail.
- All the entries should be sent to the Physical Director CMRCET by 4th September, 2017 before 2.00pm without fail. The fixtures and matches schedules will be displayed on notice board and circulated in all the sports groups on 7th September, 2017.
- All the matches will be on knock out basis.
- Sports /Discipline committee/Physical Director have right to disqualify any team or game in any circumstances.
- All the players must come in proper dress, i.e., SHORT & T.SHIRT only. Those players will be allowed for the matches.
- The matches will held only on Saturdays.

Convener

Sports & Games Committee

Principal

Copy submitted to Secretary Garu for kind information

Copy to

- 1) HODs to kindly educate the students on the above and send the lists please
- 2) A.O
- 3) Sports Committee members
- 4) To be read in the class room
- 5) Notice Board.

CMR COLLEGE OF ENGINEERING AND TECHNOLOGY

KANDLYAKOYA, MEDCHAL, HYDERABAD-501401

CMR PRO KABADDI LEAGUE



LAST DATE TO REGISTER:

4TH SEPT, 2017

CONDUCTED ON:

9TH AND 16TH OF SEPT, 2017

PRINCIPAL
CMR COLLEGE OF ENGG. & TECH.
Kandlakoya (V), Medchal Road,
Hyderabad-501401.



CMR COLLEGE OF ENGINEERING & TECHNOLOGY

(AUTONOMOUS)

NAAC Accredited Institution with 'A' Grade
Kandlakoya (V), Medchal Road, Hyderabad -501401.

Date: 05.09.2017

To,
Dr.N.Satyanarayana
Principal ,CMRIT.

Sir,

Sub: Request to be Chief Guest of CMR Pro Kabaddi League - Reg.

CMR College of Engineering & Technology is Organizing CMR Pro Kabaddi League on 9th, 16th September, 2017. It would be our great honor if you would grace the occasion as Chief Guest for the CMR Pro Kabaddi League on 9th September 2017 at 9:30 AM.

Thank you,

Major Dr. V.A.Narayana
Principal

PRINCIPAL
CMR COLLEGE OF ENGINEERING & TECHNOLOGY
Kandlakoya (V), Medchal Road, Hyderabad - 501401

**DEPARTMENT OF
PHYSICAL EDUCATION**

Cordially Invites Your Gracious Presence
On The Occasion Of

**CMR Pro Kabaddi
League**

INAUGURAL FUNCTION

On
09th September at 10:00 AM

Chief Guest
Dr.N.Satyanarayana
Principal ,CMRIT.

Venue: CMR Grounds

Programme Schedule

- 10:00 AM – INVITING THE GUESTS ON THE DAIS
- 10:05 AM – FLAG HOISTING
- 10:10 AM – VISITING TEAMS
- 10:15 AM – OATH TAKING
- 10:20 AM – ADDRESS BY DR. M. RAMALINGA REDDY,
PRINCIPAL, CMRCET
- 10:25 AM – ADDRESS BY DR. M. JANGA REDDY,
PRINCIPAL, CMRIT
- 10:30 AM – ADDRESS BY DR. ABBULU , PRINCIPAL,
CMRCP
- 10:40 AM – ADDRESS BY SRI CH. SRISAILAM REDDY,
SECRETARY & CORRESPONDENT, CMREC
- 10:50 AM – ADDRESS BY SRI CH. BHOOPAL REDDY,
VICE CHAIRMAN, CMREC
- 10:55 AM – ADDRESS BY SRI CH. GOPAL REDDY,
SECRETARY & CORRESPONDENT,
CMRGI
- 11:05 AM – ADDRESS BY CHIEF GUEST,
DR.N.SATYANARAYANA
PRINCIPAL ,CMRIT.
- 11:10 AM – DECLARING THE MEET OPEN
- 11:15 AM – VOTE OF THANKS

PRINCIPAL
CMR COLLEGE OF ENGG. & TECH.
Kandlakota (V), Medchal Road,
Hyderabad-501401.

Event Photos: CMR Pro Kabaddi League



PRINCIPAL
CMR COLLEGE OF ENGG. & TECH.
Kandlakota (V), Medchal Road,
Hyderabad-501401.

Event Report: CMR Pro Kabaddi League in the month of September 2017,

- Request letter to principal to organize the CMR Pro Kabaddi League through IQAC Coordinator.
- Got the approval from Principal to organize the CMR Pro Kabaddi League during the first two weeks of September month, and the matches were only on Saturdays.
- Circular Issued to students for the CMR Pro Kabaddi League and asked for entries.
- There were 6 teams who registered for this event.
- The Draws have been taken out in the presence of 3 committee members and the captains of various teams. Draws were like this,
 - i) EEE v/s MECH winner of these two teams played with CIVIL, CIVIL team has got bye.
 - ii) In the second half ECE v/s CSE winner of these two played with MBA, MBA team has got bye.
 - iii) Finally the result was ECE winners and CIVIL runners up.
- It is very much required for students to have physical activity once in a week. The students' involvement in academics is more like Mid Exam's /Labs etc. During the week end there must be a recreation/any physical activity to overcome the stress.
- And also in the weekend the other students have enjoyed a lot by encouraging their department team. They also got relaxed after a week full of stress.
- The matches were conducted in the Kabaddi Court of CMRCET
- The resources from the college were only play fields.
- 8 students from Sports Club were involved in the event they made it success, and also the faculty of various departments was present when and where their department team is playing without any disturbance the event was completed.

Outcomes:

During these matches few students who are good at Kabaddi game skills got selected for further training and they can be sent for college team, other university and National level

Thanking you sir

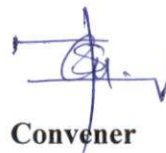

Convener
Sports & Games Committee



CMR COLLEGE OF ENGINEERING & TECHNOLOGY

(AUTONOMOUS)

NAAC Accredited Institution with 'A' Grade

Kandlakoya (V), Medchal Road, Hyderabad -501401.

21/08/2017

To
The Principal
CMRCET

Through: IQAC Coordinator

Sub: Permission to organize 4th Telangana State Inter Engineering Collegiate Football
Tournament – 2017– Reg.

Respected Sir,

As per the approval from the IQAC for the sports events proposed to be conducted in the A.Y: 2017-18, the Sports & Games Committee would like to organize 4th Telangana State Inter Engineering Collegiate Football Tournament from 22nd to 24th September 2017. I request your kind approval to conduct the above said tournament.

- Dates of the Event: 22nd to 24th September, 2017.
- Name of the Event: 4th Telangana State Inter Engineering Collegiate Football Tournament.
- Importance: To get exposure to the outside games world
To get harmony & competitive spirit
To maintain cordial relation among players of various colleges
- Venue: CMRCET Football Grounds.
- Target Audience: Students of various colleges all over Telangana.
- Resources required: Play fields, Playing Equipments, Footballs and Goal Nets, marking Powder, Corner Flags and Referees.
- Amount required: Rs1,57,400/-

Faculty members who are involved in the sports committee will be taking care of the matches and also the student members of the sports club will help for the smooth conduction of the tournament.

Thanking you sir,

Recommended
[Signature]

Coordinator
Internal Quality Assurance Cell
Office: 10th Floor, Block 'A', CMRCET
Kandlakoya (V), Medchal Road, Hyderabad -501401.

[Signature]

Convener
Sports & Games Committee

[Signature]

PRINCIPAL
CMR COLLEGE OF ENGG. & TECH.
Kandlakoya (V), Medchal Road,
Hyderabad-501401.



CMR GROUP OF INSTITUTIONS

Kandlakoya (V), Medchal Road, Hyderabad-501401

website: www.cmrct.org

Ph. No. 08418 - 224988, 260699 Mob: 9248727216

Chief Patron:

Sri Ch. Malla Reddy
Chairman, CMRGI.

Patrons:

Sri Ch. Narasimha Reddy
Vice-Chairman, CMRGI.

Sri Ch. Bhoopal Reddy
Executive Member, CMRGI.

Sri Ch Srisailam Reddy
Executive Member, CMRGI.

President:

Sri Ch. Gopal Reddy
Secretary & Correspondent,
CMRGI.

Organizing Committee:

Chairman:

Major Dr. V.A.Narayana
Principal, CMRCET.

Organizing Secretary:

Mr. Syed Rafeeq
Asst. Prof. in Phy. Edn.
98491 00278
92487 27216

Executive Members:

Mr. P.M.M. Reddy
Admin Officer

Mr. T.Mohan Rao
Asst. Prof. in Phy. Edn.
Cell: 9885545506

Mr. G. Shyam Sundar
PD, CMRCP.
Cell:9052000858

Mr. Y.Ugander Reddy
P D, CMRTC
Cell: 9866564422

Mr. Rajesh Goud
P D, CMREC
Cell:9885832324

Mr. Sridher
P D, CMRTC
Cell; 9000213115



Date: 29.08.2017

To
The Principals
JNTUH and O.U Affiliated colleges

Sir/Madam,

Sub: IV Telangana State Inter Engineering collegiate FOOT
BALL Tournament – 2017, request for participation – Reg.

We take pleasure in hosting the Inter collegiate Foot Ball
Tournament (for JNTUH and O.U Affiliated colleges) and on this
occasion we extend our cordial invitation to the principals of the
Engineering colleges under JNTUH / O.U Hyderabad.

We request for enthusiastic participation of your college team in
the tournament to be organized from 22nd to 24th Sept, 2017, at
CMR COLLEGE OF ENGINEERING AND TECHNOLOGY,
Medchal Road, Secunderabad. Last date of entries is 18th Sept,
2017. Kindly send the entries of your college team for
participation in the tournament along with the entry fee Rs. 1700/-
payable by Cash/DD Drawn in favor of Principal CMR College
Engineering & Technology Payable at Hyderabad.

Once again we welcome your college team to participate in IV
Telangana State Inter Engineering collegiate Foot Ball
Tournament-2017 and make it a grand success.

Note: No spot Registrations.

Thanking you,

Yours faithfully,

29/8/17
PRINCIPAL

CMR College of Engineering & Technology
Kandlakoya (V), Medchal Road,
Hyderabad-501 401.

IV TELANGANA STATE INTER ENGINEERING COLLEGIATE FOOT BALL TOURNAMENT – 2017.

Rules and Regulations

- Students pursuing B. Tech, M. Tech, MBA, and Pharmacy courses in the engineering and pharmacy colleges of JNTUH/ O.U Affiliated.
- One team shall represent their respective college.
- The venue for conducting the tournament is CMR Group of Institutions located on NH 7, Kandlakoya, Medchal Road, Hyderabad. 501 401. Bus Route is 229 from Secunderabad to Medchal.
- Lunch, tea and snacks will be available at nominal rates.
- Unfurnished accommodation will be provided for outstation teams only on previous day of their match, on their request.
- Teams should be dressed in their college colour.
- Playing teams should be present on the specified ground at least 30 minutes before of their match. Walk over will be given by the Referees if teams do not report on time.
- Players should be in the possession of valid ID cards issued by the respective college principal (no bonafide certificate/Hall Ticket will be accepted)
- Referees decisions are final and binding.
- The teams have to report for the inaugural function with their college flag on 22nd Sept, 2017 at sharp 9.30am, the team which fail's to attend the function will not be allowed for the tournament.



Organizing Secretary



CMR College of Engineering & Technology
 Kandlakoya, Medchal, Hyderabad - 501401.



IV-TELANGANA STATE INTER ENGINEERING COLLEGIATE

FOOTBALL TOURNAMENT 2017

*****From 22nd to 24th SEPT, 2017 at CMRCET*****

****NO SPOT REGISTRATION****



**ENTRY FEE
1700/-**

**LAST DATE
OF ENTRY
18TH SEPT 2017**



ORGANISING COMMITTEE CHAIRMAN:
MAJOR Dr. V.A.NARAYANA
 Principal CMRCET

ORGANISING COMMITTEE PRESIDENT:
CH.GOPAL REDDY
 Secretary & Correspondent
 CMR Group Of Institutions

ORGANISING SECRETARY: SYED RAFEEQ
 Physical Director CMRCET
 (9248727216 , 9849100278)



ORGANISING TEAM:
VAMSI KRISHNA - 7207262816
SHRAVAN - 8125058247

CMR
Kar



CMR COLLEGE OF ENGINEERING & TECHNOLOGY

(AUTONOMOUS)

NAAC Accredited Institution with 'A' Grade
Kandlakoya (V), Medchal Road, Hyderabad -501401.

Date: 15.09.2017

To,
Sri. Ch. Malla Reddy
Member of Parliament.

Sir,

Sub: Request to be Chief Guest of 4th TSIEC Football Tournament - Reg.

CMR College of Engineering & Technology is Organizing 4th TELANGANA STATE INTER ENGINEERING COLLEGIATE FOOTBALL TOURNAMENT – 2017 from 22nd to 24th Sept, 2017. It would be our great honor if you would grace the occasion as Chief Guest for the TSIEC Football Tournament on 22nd Sept, 2017 at 9:30 AM.

Thank you,

Major Dr. V.A. Narayana
Principal

PRINCIPAL
CMR COLLEGE OF ENGG. & TECH.
Kandlakoya (V), Medchal Road,
Hyderabad-501401.



CMR COLLEGE OF ENGINEERING & TECHNOLOGY

(Autonomous)

NAAC Accreditation Institution with 'A' Grade

Kandlakoya(V), Medchal Road, Hyderabad - 501401.



CMR COLLEGE OF ENGINEERING & TECHNOLOGY

(Autonomous)

NAAC Accreditation Institution with 'A' Grade

Kandlakoya(V), Medchal Road, Hyderabad - 501401.



EXPLORE TO INVENT

SPORTS INVITATION

To : _____

**"HARDWORK WINS GAMES. BUT
TEAMWORK AND INTELLIGENCE WIN
CHAMPIONSHIPS."**

PRINCIPAL
CMR COLLEGE OF ENGG & TECH.
Kandlakoya (V), Medchal Road,
Hyderabad-501401.

PRINCIPAL
CMR COLLEGE OF ENGG & TECH.
Kandlakoya (V), Medchal Road,
Hyderabad-501401.



CMR COLLEGE OF ENGINEERING & TECHNOLOGY

(AUTONOMOUS)

NAAC Accredited Institution with 'A' Grade
Kandlakoya (V), Medchal Road, Hyderabad -501401.

Date: 06th September 2017

To
The Secretary,
TFA Hyderabad

Sub: Request for allotment of Officials for **4th TELANGANA INTER
ENGINEERING COLLEGIATE FOOTBALL TOURNAMENT** - Reg.

Sir;

CMR COLLEGE OF ENGINEERING & TECHNOLOGY is going to organize **4th TELANGANA INTER ENGINEERING COLLEGIATE FOOTBALL TOURNAMENT 2017** from 22nd to 24th September 2017. Hence I request you to kindly spare the services of **TELANGANA FOOTBALL ASSOCIATION REFEREES** for smooth conduction of the tournament and make it a grand success.

Thanking you

Major Dr.V.A.Narayana
Principal

PRINCIPAL
CMR COLLEGE OF ENGG. & TECH.
Kandlakoya (V), Medchal Road,
Hyderabad-501401.

Event Photos: 4th TSIEC Football Tournament.

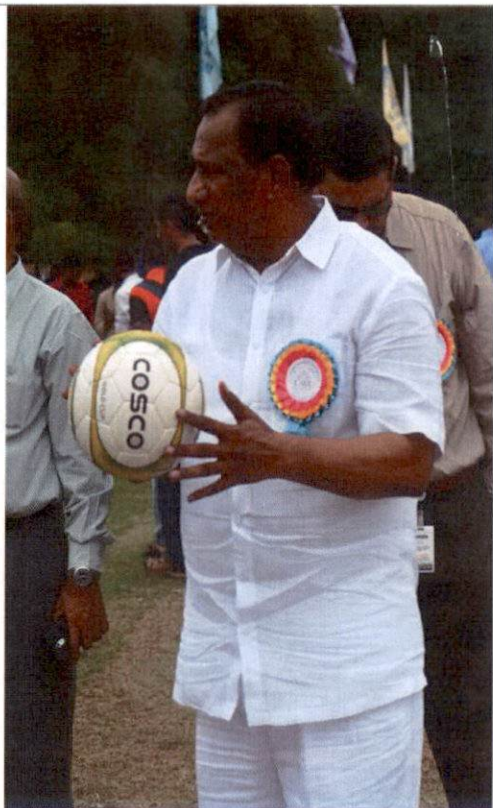

PRINCIPAL
CMR COLLEGE OF ENGG & TECH.
Kandlakoya (V), Medchal Road,
Hyderabad-501401.



PRINCIPAL
CMR COLLEGE OF ENGG. & TECH.
Kandlakoya (V), Medchal Road,
Hyderabad-501401.

Event Report: 4th Telangana State Inter Engineering Collegiate Football Tournament in the month September 2017,

- Request letter to principal to organize 4th Telangana State Inter Engineering Collegiate Football Tournament – 2017 through IQAC Coordinator. Got the approval from Principal to organize the Tournament from 22nd to 24th September 2017.
- Invitation issued to various Engineering colleges of Telangana asking them for entries. Last date of entries was 18th September 2017.
- There were 35 teams who registered for the tournament.
- The Draws have been taken out in the presence of all the officials, Physical Director and Captains of various colleges.
- The chief guest for the inaugural ceremony was Sri Ch. Malla Reddy, Member of Parliament.
- Finally the result was Indian institute of information and technology winner & Malla Reddy Engineering college was Runnerup.
- The matches were conducted in the Main Grounds of CMR College of Engineering & Technology
- Resource persons Referees from Telangana Football Association for smooth conduction of the tournament were invited.
- 10 students from Sports Club & 3 students from photography club were involved in the tournament and they made it grand success, and also the sports committee members of our college were present for this tournament.
- Closing ceremony, Prize distribution was held on 24th September 2017, the chief guest for the function was Shri. Ch. Gopal Reddy , Secretary & Correspondent, CMRGI
- The budget sanctioned for the tournament was Rs. 1,57,400/- and the expenditure for the tournament was Rs. 1,68,449/- . The account has been settled immediately after the tournament.

Thanking you sir



Convener
Sports & Games Committee

**IV TELANGANA STATE INTER ENGINEERING COLLEGIATE
FOOT BALL TOURNAMENT - 2017**

Approximate estimation for the Tournament

1. Banners etc		Rs. 3,000/-
2. Prizes		Rs. 18,000/-
a) Winner Cups		
b) Runner Cups		
c) Individual Prizes		
d) Certificates		
3. Invitation for Colleges (Postal & Petrol)		Rs. 5,000/-
4. Inaugural Function		Rs. 4,000/-
a) Crackers		
b) Gas Baloons,		
c) Bouquet etc		
5. Umpires Remuneration (8 member x 3 days)		Rs. 30,000/-
6. Gifts for Officials (CMR Printed Bag/T-Shirt etc)		Rs. 12,500/-
7. Medical Kit		Rs. 500/-
8. Team Kit (Dress)		Rs. 5,400/-
9. Foot Ball's (Match Ball) & Goal Net		Rs. 10,000/-
10. Labour and white powder		Rs. 5,000/-
11. Lunch, Tiffin for Referees & Official		Rs. 7,500/-
12. Tent House		Rs. 7,500/-
13. Goal post		Rs. 49,000/-
	Total	<u>Rs. 1, 57,400/-</u>
14. Team Entries (1700x36)		Rs. 59,500/-
	Approximate Total	<u>Rs. 98,000/-</u>

PRINCIPAL
CMR COLLEGE OF ENGG. & TECH.
Kandlakoya (V), Medchal Road,
Hyderabad-501401.

Physical Director

**IV TELANGANA STATE INTER ENGINEERING COLLEGIATE
FOOT BALL TOURNAMENT - 2017**

**Approximate estimation and actual spent amount for the
Tournament**

	Approx Amount	Actual Amount	
1. Banners etc	Rs. 3.000/-	2.450.00	✓
2. Prizes	Rs. 18.000/-	18.786.00	✓
a) Winner Cups			
b) Runner Cups			
c) Individual Prizes			
d) Certificates			
3. Invitation for Colleges (Postal & Petrol)	Rs. 5.000/-	2.279.00	✓
4. Inaugural Function	Rs. 4.000/-	4.507.00	✓
a) Crackers			
b) Gas Baloons,			
c) Bouquet etc			
5. Umpires Remuneration (8 member x 3 days)	Rs. 30.000/-	33.300.00	✓
6. Gifts for Officials (CMR Printed Bag/T-Shirt etc)	Rs. 12.500/-	11.250.00	✓
7. Medical Kit	Rs. 500/-	230.00	✓
8. Team Kit (Dress)	Rs. 5.400/-	8.000.00	✓
9. Foot Ball's (Match Ball) & Goal Net	Rs. 10.000/-	9.318.00	✓
10. Labour and white powder	Rs. 5.000/-	5.400.00	✓
11. Lunch, Tiffin for Referees & Official	Rs. 7.500/-	7.185.00	✓
12. Tent House	Rs. 7.500/-	14.000.00	✓
13. Goal Post	Rs. 49.000/-	51.744.00	✓
Total	Rs. 1, 57,400/-	1, 68,449.00	
14. Team Entries (1700x36)	Rs. 59.500/-	51.000.00	✓
15. Advance taken	--	50.000.00	✓
Approximate Total	Rs. 97,900/-	1.01.000.00	

Cheque Amount

67,449.00

51,744.00

15,705.00

Physical Director

PRINCIPAL
CMR COLLEGE OF ENGG & TECH
Kandlakoya (V), Medchal Road,
Hyderabad-501401.

20/10/17

Handwritten notes:
A check
19/10/17 please pay the cheque
and the balance amount
and close the account
10/10/17

Handwritten note:
A.O.S in the
place to her

Handwritten notes:
cheque must
this amount
was to be
given

TAX INVOICE

N NO.: 36AABFE8927D1ZI

BILL No. 912

Date: 4/10/2017

CREDIT / CARDS / BANK



ESS HAN

(SSI UNIT No. 280061102310 A Govt Of
Shop No. 9 & 10, Cellar, Hardy Complex, M.G
Ph : 040-278198
E-mail : esshandicrafts27819834@gmail
Works : Hasmat

AFTS

men's Small Scale Unit
d - 500 003, TELANGANA,
05
;_hyd@yahoo.co.in

To: The principal
CMR college of Eng & Technology

Buyer

18786.0

Buyer's

9248727216

D.C. No.

no. Of Pkgs.

Sl. No.	PARTICULARS / DESCRIPTION	HNS Code	Qty.	Rate	Amount
1	Sprement's winner cup		1p	3000/-	3000 ~
2	" Runner cup		1p	2500/-	2500 ~
3	" Individual cup		18p	105/-	1890 ~
4	" Individual cup		18p	85/-	1530 ~
5	" Referees Certi		4p	250/-	1000 ~
6	" Chief guest		2p	800/-	1600 ~
7	" Certificati		8p	550/-	4400 ~
Sub Total					15920 ~
Central Tax (GST)					9% 1433 ~
State Tax (SGST)					9% 1433 ~
Integrated Tax (IGST))
TOTAL					18786 ~

E & O.E. Rupees in words: eighteen thousand seven hundred 4 For **ESS HANDICRAFTS**

Bank Details : **ANDHRA BANK**, M.G. Road, Secunderabad.
A/c No. 036213046002460 • IFSC Code : ANDB0000362

eighty six rupees Only. Blaner
Authorized Signatory

PRINCIPAL
CMR COLLEGE OF ENGG. & TECH.
Kandlakoya (V), Medchal Road,
Secunderabad-501401.



TAX INVOICE

Platinum Jr

8 - 2013

**REGAL
SPORTS CO.**

127, MAHATMA GANDHI ROAD,
SECUNDERABAD - 500 003.
TELANGANA.

Phone : 27842346, 27840692
E-mail : regalsports@gmail.com



Bill No. 49288
To, THE 1
CM
(CET
R.

19/2012
age
chal
49168

Interest at 1% per mensem will be charged on all accounts not se

S.No.	PARTICULARS	Rate	Amount	
			Rs.	Ps.
①	6 nos. FOOTBALLS Cosco Delta Force P/sre HSN-95066210. Each	1080/-	6480	00
②	2 PAIR FOOTBALL goal net gupta Nylon all DOUBLE THICK HSN-95069960. Each	1960/-	3920	00
			10400	00
	Less Discount 20%		2080	00
			8320	00
	SGST - 6% CGST - 6%	12%	998	00
	TOTAL		9318	00

REGAL SPORTS COMPANY
127, M.G. ROAD,
SECUNDERABAD-500 003.
GSTIN: 36ABVPD6817A1ZP
E. & O. E.



TIN No. : 36555493868
PAN No. : ABVPD6817A

For REGAL SPORTS CO.
[Signature]
Manager.

PRINCIPAL
CMR COLLEGE OF ENGG. & TECH.
Kandlakoya (V), Medchal Road,
Hyderabad-501401.

BILL

49
53



SRI VENKAESHI TENT HOUS

Vinayak Nagar Colony, Road No.1
Near Ayyappa Temple, Medchal, Medcl

14000/- T.S
17

No.
Name..... C.M.R. College
Address.....

S.No.	PARTICULARS	NT
1	12/16 - Tent	10
2	C.Hawk's - 15	1500
3	Green Matt - 3	600
4	Scrine Powder - 2	400
5		4000
6	22/9/19 to 24 (3 days)	3X
8		
9		12000
10	8/4 - Tent - 1	
11	22823 (2 days)	1400
12		
13	Transport -	600
14		14000
15		
16		
17		
19		
20		
21		
22		
23		
24		

Transport Charges

TOTAL 14000/-
ADV.
BAL.

PRINCIPAL
CMR COLLEGE OF ENGG & TECH.
Kandlakoya (V), Medchal Road
Hyderabad-501401. *Thanking You*
Visit Again

For: SRI VENKATESHWARA TENT HOUSE



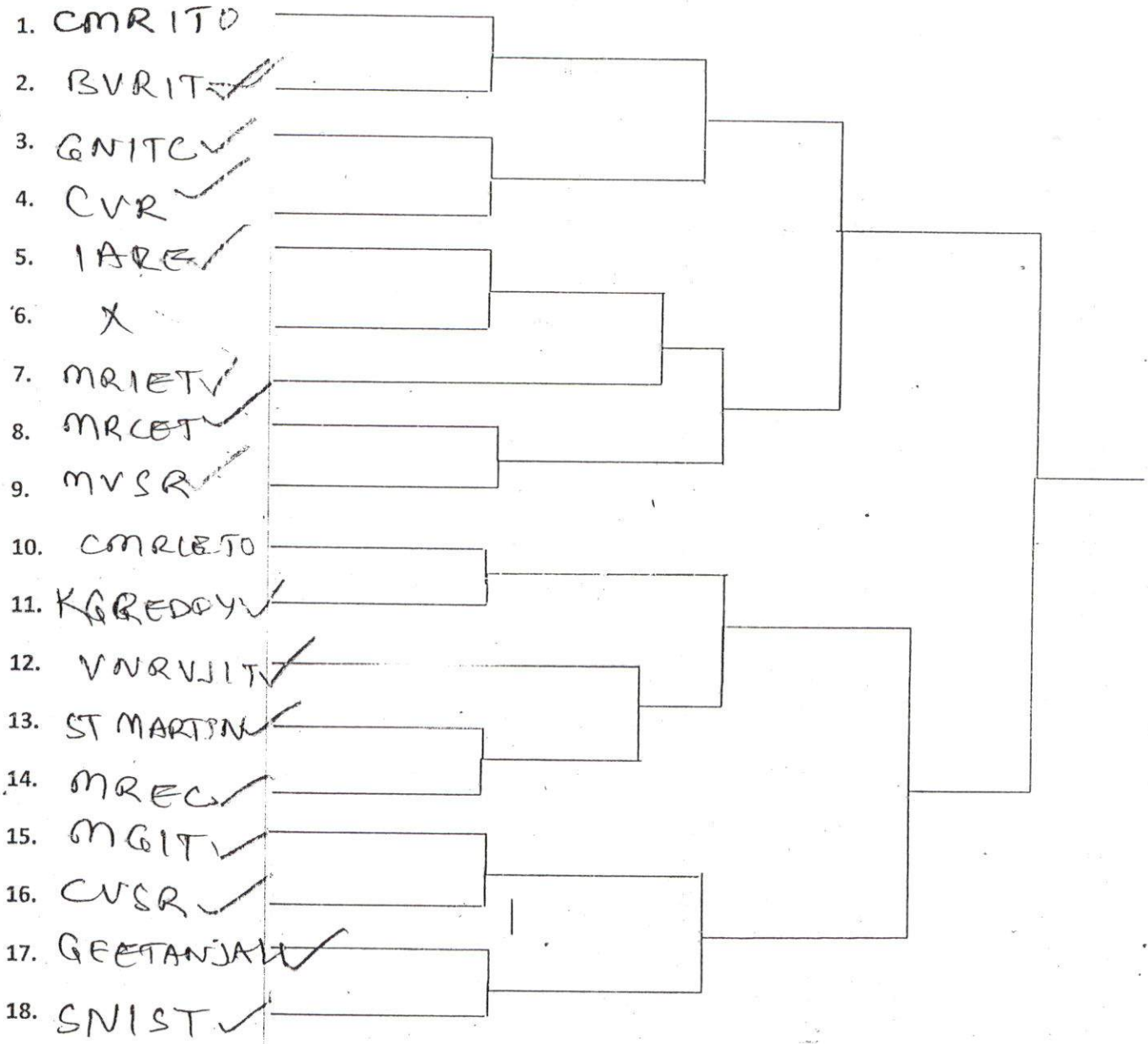

[Signature]
Signature

IV TSIEC FOOTBALL TOURNAMENT – 2017
 Organized by CMRCET, from 22nd to 24th September, 2017

FIXTURES POOL-A

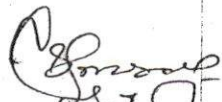
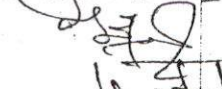

Member's:

1.  (CHANDRA SEKHAR)
2. 
3.  T. Mohan Rao
4.  K. Dipak Kumar
5.  LORDS, MD, AEE



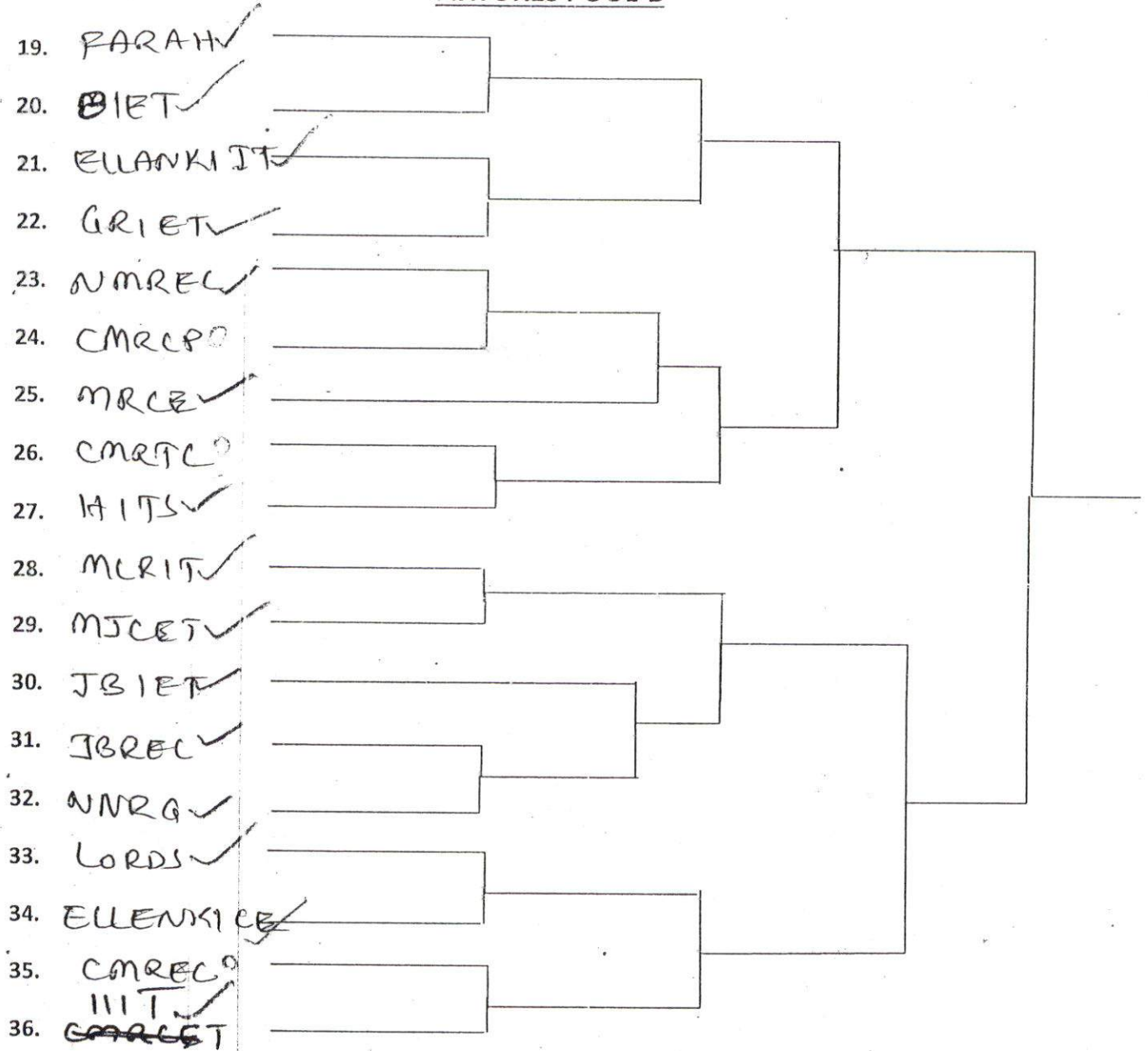

 ORGANISING SECRETARY
PRINCIPAL
 CMR COLLEGE OF ENGG. & TECH.
 Kandlakoya (V), Medchal Road,
 Hyderabad-501401.

IV TSIEC FOOTBALL TOURNAMENT – 2017
 Organized by CMRCET, from 22nd to 24th September, 2017

FIXTURES POOL-B

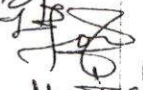

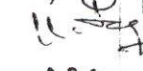
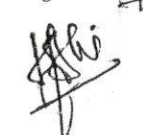
Member's:

1.  (Srinivas Sekhar)
2. 
3.  (T Mohan Rao)
4.  (M. Ramesh Kumar)
5. 

LORDS
MD-ACE

PRINCIPAL ORGANISING SECRETARY
 CMR COLLEGE OF ENGG. & TECH.
 Kandlakoya (V), Medchal Road,
 Hyderabad-501401.



CMR COLLEGE OF ENGINEERING & TECHNOLOGY

AN UGC AUTONOMOUS INSTITUTION

(Approved by AICTE, Permanently Affiliated to JNTU Hyderabad)

(NAAC Accredited Institutions with 'A' Grade)

Kar., Jlakoya, Medchal Road, Hyderabad - 501 401. Phone : (08418) 200699, 9248727210, www.cmrct.

PAYMENT LETTER

Date 8-9-17

From

Name Syed Rafiq
Designation P.D.
In-charge
Dept. Physical Education

17-18

To

The Principal

Sir,

Sub: Payment to M/s Regal Sports Co. Request Reg.

Ref: I. Our order No. 01 Dated 29.8.17

II. Invoice No. 49268 Dated 7.9.17

We have placed Order an amount of Rs. 51,744.00 (in words Fifty One thousand Seven hundred Forty Four) equipment for the library

Department on M/s Regal Sports Co. With purchase order no. cited in Ref. I

We have received the equipment from the above mentioned firm with good condition and working satisfactory. Hence I request you to pay the following amount to the above mentioned firm.

A) Total Ordered Amount	Date <u>29.8.17</u> Rs. <u>51,744.00</u>
B) Advance Paid along with Purchase Order	Date Rs.
C) Amount paid / to be paid against invoice No.	Date Rs.
D) Amount paid / to be paid against invoice No.	Date Rs.
E) Amount paid/to be paid against invoice No.	Date Rs.
F) Amount paid /to be paid against invoice No.	Date Rs.

Total Rs 51,744.00

(Amount to paid (A-B-C-D-E-F) (in words Fifty One thousand Seven hundred Forty Four only))

Thanking you
Yours faithfully,
In-charge

V. S. ...
7/9/17

Accounts
To Amt
pay che
17/10/17

[Signature]
Recommended & Forwarded

Head of the Department
PRINCIPAL
CMR COLLEGE OF ENGG. & TECH.
Kandlakoya (V), Medchal Road,
Hyderabad-501401.

Child's Play
ROAD,
13.
40692
mail.com
1ZP

BILL NC 9268
Delivery Challan No.: 13624
To, The Principal,
CMR College of Engineering & Technology (CET),
Medchal, R.R.District.
HYDERABAD.
GST: NIL

DATE: 07-09-17
DATE: 07-09-2017



P.O No. NIL

Item Description	HSN	Qty	Rate	Amount	Taxable value	GST Rate	CGST 6%	SGST 6%	Total
Pipe Moveable with	95069990	1 Pair	44000-00	44000-00	44000-00	12%	2640-00	2640-00	49280-00
					2200-00	12%	132-00	132-00	2464-00
					46200-00		2772-00	2772-00	51744-00

and seven hundred and forty four only

Certified that the goods and equipment received in good condition as per specification and entered in stock Book No: 2 Page No: Item No: Paid in cash/ cheque No: 51,744.00 Dt:

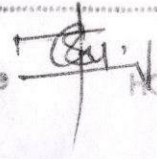
In-charge  NOD PRINCIPAL

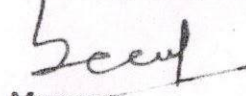
For Regal Sports Co.

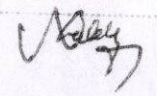
Manager

CMR GROUP OF INSTITUTIONS
KANDLAKOYA, MEDCHAL
Date 09/09/17 Time 11-10
S.No. 145

PRINCIPAL
CMR COLLEGE OF ENGG. & TECH.
Kandlakoya (V), Medchal Road,
Hyderabad-501401.



PLOT NO.1 TO 7 G.K.PROPERTIES,
RANGAREDDY,MEDCHAL,HYDERABAD-501401,TELANGANA
RTGS / NEFT IFSC : HDFC0001640

A/c Pay Only

Preferred

Weekly Holiday on SUNDAY

								09	09
								20	17

D D M M Y Y Y Y
Valid for 3 months only

Pay REGAL SPORTS CO.

Or Bearer

Rupees रुपये

** Fifty One Thousand Seven Hundred Forty Four Rupees

या धारक को
XXXXXXXX

Only**

अदा करें

₹

** 51,744 /--

A/c No.
बैंक अकाउंट नंबर

16408640000031

Brn: 1640 Pdt:864
APEX CA

For CMR COLLEGE OF ENGINEERING AND TECHNOLOG

Payable at par through clearing/transfer at all branches of HDFC BANK LTD

Authorised Signatories

Please sign above / कृपया यहाँ हस्ताक्षर करें

⑈ 10 20 38 ⑈ 500 24 00 39 ⑈ 00 17 6 5 ⑈ 29

[Signature]
PRINCIPAL
CMR COLLEGE OF ENGG. & TECH.
Kandlakoya (V), Medchal Road,
Hyderabad-501401.



C.M.R. COLLEGE OF ENGINEERING & TECHNOLOGY

V.R. No.....

CASH PAYMENT

Dated 25.9.17 20

	AMOUNT	
	Rs.	Ps.
CREDIT		
Cash Paid to Mr. Syed Hashim		
→ wards officiating charges		
For Fest Cell Tournament	33,300	00
Rupees	33,300	00

Prepared by

Checked by

Receiver's Signature

PRINCIPAL
CMR COLLEGE OF ENGG. & TECH.
Kandlakota (V), Medchal Road,
Hyderabad-501401.



Cell : 9948142312
9177311666

SRI CHILUKURI BALAJI CATERING SERVICES

Plot No.4, Sri Ganesh Nilayam, Venkata Ramaiah Colony,
Medchal, Medchal Dist. - 501 401.

Website: www.chilukuribalajicatering.com, E-mail : nvsreddy1122@gmail.com

No.

Date: 25.9.17

M/s. *Principal CMR College of Engineering & Tech*

Date	PARTICULARS	Qty.	RATE	AMOUNT	
				Rs.	Ps.
1	Meals	600	60	36,000	00
2	Snacks	150	30	4,500	00
TOTAL				40,500	00

Rs. in words :

Thank you

For Sri Chilukuri Balaji Catering Services

Signature

PRINCIPAL
CMR COLLEGE OF ENGG. & TECH.
Kandlakota (M), Medchal Road,
Hyderabad-501401.



CMR COLLEGE OF ENGINEERING & TECHNOLOGY

(AUTONOMOUS)

NAAC Accredited Institution with 'A' Grade

Kandlakoya (V), Medchal Road, Hyderabad -501401.

02.10.2017

To
The Principal
CMRCET

Through: IQAC Coordinator

Sub: Permission to organize Engineer's Throw Ball & Indoor Games Tournament Req. – Reg.

Respected Sir,

As per the approval from the IQAC for the sports events proposed to be conducted in the A.Y: 2017-18, the Sports & Games Committee will organize Engineer's Throw Ball & Indoor Games Tournament on every Saturday in the month of October 2017. I request your kind approval for the Conduct of the events.

- Dates of the Events: 7th, 14th & 21th, 28th of October, 2017.
- Name of the Events: Engineer's Throw Ball & Indoor Games Tournament
- Importance: To bring out their hidden talents & to train them further.
To select them for college team, other university & National level.
- Venue: CMRCET Throwball court and Indoor complex
- Target Audience: Students of respective department.
- Resources required: Play fields & playing Equipment.

Faculty members who are involved in the sports committee will be taking care of their respective department match & also the student members of the sports club will help the smooth conduct of the event.

Thanking you sir,

Recommended
Agonur,
Coordinator
Internal Quality Assurance Cell
CMR College of Engineering & Technology
Kandlakoya (V), Medchal Road,
Hyderabad - 501 401.

Convener
Sports & Games Committee

Approved



CMR COLLEGE OF ENGINEERING & TECHNOLOGY

(AUTONOMOUS)

NAAC Accredited Institution with 'A' Grade

Kandlakoya (V), Medchal Road, Hyderabad -501401.

CMRCET/PRIN/ SPORTS/AY2017-18/CIR-05

Date: 04/10/2017

Sports & Games Circular

All the students are hereby informed that, the Engineer's Throw Ball & Indoor Games Tournament is scheduled on every Saturdays in the month of October 2017. In this regard all the departmental Throwball and Indoor game teams should give their team entry by filling the entry form.

The following are the maximum number of players allowed from each department for the respective game mentioned below:

E V E N T :

1. Throwball 10 Players(7+3)
2. Indoor Games 4 from each department
- a) Department team must submit the eligibility form of their players duly signed by HOD and sports in-charge of the respective department. The in-charge of particular department must be present when their department team is playing the match without fail.
- b) All the entries should be sent to the Physical Director CMRCET by 5st October, 2017 before 2.00pm without fail. The fixtures and matches schedules will be displayed on notice board and circulated in all the sports groups on 6rd October, 2017.
- c) All the matches will be on knock out basis.
- d) Sports /Discipline committee/Physical Director have right to disqualify any team or game in any circumstances.
- e) All the players must come in proper dress, i.e., SHORT & T.SHIRT only. Those players will be allowed for the matches.
- f) The matches will held only on Saturdays.

Convener

Sports & Games Committee

Principal

Copy submitted to Secretary Garu for kind information

Copy to

- 1) HODs to kindly educate the students on the above and send the lists please
- 2) A.O
- 3) Sports Committee members
- 4) To be read in the class room
- 5) Notice Board.

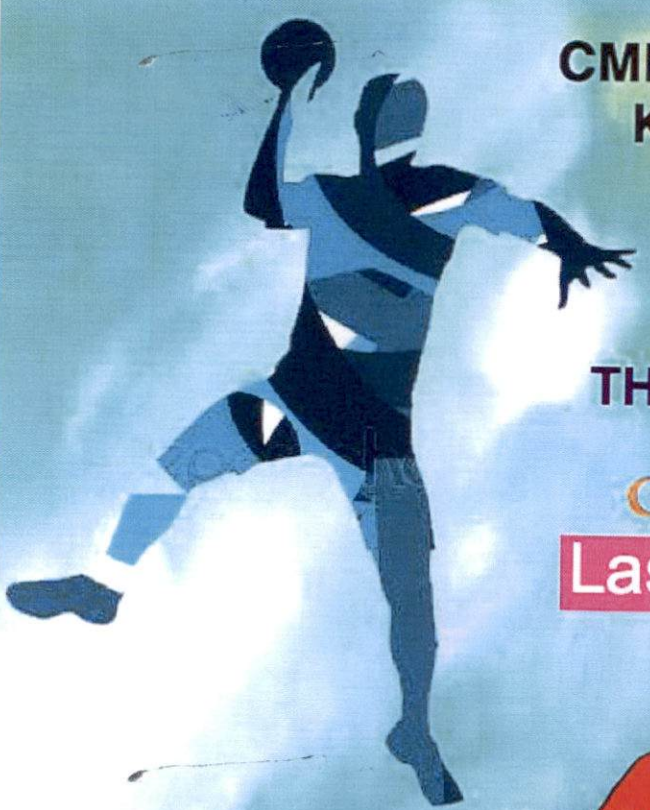

**CMR COLLEGE OF ENGINEERING AND TECHNOLOGY
KANDLAKOYA, MEDCHAL, HYDERABAD -501401**

**ENGINEER'S
THROW BALL & INDOOR GAMES TOURNAMENT**

Conducted on 7th, 14th, & 21st, 28th of October 2017

Last date for registrations: 5 October 2017



PRINCIPAL
CMR COLLEGE OF ENGG. & TECH.
Kandlakoya (V), Medchal Road,
Hyderabad-501401.



CMR COLLEGE OF ENGINEERING & TECHNOLOGY

(AUTONOMOUS)

NAAC Accredited Institution with 'A' Grade
Kandlakoya (V), Medchal Road, Hyderabad -501401.

Date: 03.10.2017

To,
Dr.S.Abbulu
Principal
CMRCP.

Sir,

Sub: Request to be Chief Guest of Engineer's Throw ball & Indoor Games Tournament-
Reg.

CMR College of Engineering & Technology is Organizing Throw ball & Indoor Games Tournament on 7th, 14th, 21st, 28th October, 2017. It would be our great honor if you would grace the occasion as Chief Guest for the Throw ball & Indoor Games Tournament on 7th October 2017 at 9:30 AM.

Thank you,

Major Dr.V.A.Narayana
Principal

PRINCIPAL
CMR COLLEGE OF ENGG. & TECH.
Kandlakoya (V), Medchal Road,
Hyderabad-501401.

**DEPARTMENT OF
PHYSICAL EDUCATION**

Cordially Invites Your Gracious Presence
On The Occasion Of

**ENGINEERS
THROWBALL & INDOOR
GAMES TOURNAMENT**

INAUGURAL FUNCTION

On
7TH OCT, 2017 at 10:00 AM

Chief Guest
Dr. S. Abbulu

PRINCIPAL CMRCP

Venue: CMR Grounds

PRINCIPAL
CMR COLLEGE OF ENGG. & TECH.
Kandlakoya (V), Medchal Road,
Hyderabad-501401.

Programme Schedule

- 10:00 AM – INVITING THE GUESTS ON THE DAIS
- 10:05 AM – FLAG HOISTING
- 10:10 AM – VISITING TEAMS
- 10:15 AM – OATH TAKING
- 10:20 AM – ADDRESS BY MAJOR DR. V A NARAYANA ,
PRINCIPAL, CMRCET
- 10:25 AM – ADDRESS BY DR. M. JANGA REDDY,
PRINCIPAL, CMRIT
- 10:30 AM – ADDRESS BY DR. ABBULU , PRINCIPAL,
CMRCP
- 10:40 AM – ADDRESS BY SRI CH. SRISAILAM REDDY,
SECRETARY & CORRESPONDENT, CMREC
- 10:50 AM – ADDRESS BY SRI CH. BHOOPAL REDDY,
VICE CHAIRMAN, CMREC
- 10:55 AM – ADDRESS BY SRI CH. GOPAL REDDY,
SECRETARY & CORRESPONDENT,
CMRGI
- 11:05 AM – ADDRESS BY CHIEF GUEST,
DR. S. ABBULU,
PRINCIPAL, CMRCP
- 11:10 AM – DECLARING THE MEET OPEN
- 11:15 AM – VOTE OF THANKS

Event Photos: Engineer's Throw Ball & Indoor Games Tournament



PRINCIPAL
CMR COLLEGE OF ENGG. & TECH.
Kandlakoya (V), Medchal Road,
Hyderabad-501401.

Event Report: Engineer's Throw Ball & Indoor Games Tournament in the month of October 2017

- Request letter to the principal to organize the Engineer's Throw Ball & Indoor Games Tournament through IQAC Coordinator.
- Got the approval from Principal to organize the Engineer's Throw Ball & Indoor Games Tournament during all Saturdays in the month of October.
- Circular issued to students for Engineer's Throw Ball & Indoor Games Tournament and asked for entries.
- There were 6 teams who registered for Throwball event.
- There were 4 players from each department who registered for respective Indoor games.
- The Draws have been taken out in the presence of 3 committee members and the captains of various teams. Draws were like this,
 - i) CSE v/s MBA winner of these two teams played with CIVIL, CIVIL team has got bye.
 - ii) In the second half ECE v/s EEE winner of these two played with MECH, MECH team has got bye.
 - iii) Finally the result was MECH winners and CSE runners up.
- The Throw ball matches conducted for Girls only.
- It is very much required for students to have physical activity once in a week. The students' involvement in academics is limited to writing Mid Exam /Labs etc. During the week end there must be a recreation/any physical activity to overcome the stress at the end of the week.
- And also in the weekend the other students have enjoyed a lot by encouraging their department team. They also got relaxed after a week full of stress.
- The matches were conducted in the Throw ball Court, Indoor at Indoor complex of CMRCET
- The resources from the college were only play fields & playing Equipment.
- 8 students from Sports Club were involved in the event they made it success. The faculty of various departments was present when their department team is playing. The event was completed without any incident.

Outcomes:

During these matches few students who are good at Throwball & Indoor game skills got selected for further training and they can be sent for college team to play at other university & National level

Thanking you sir



Convener
Sports & Games Committee



CMR COLLEGE OF ENGINEERING & TECHNOLOGY

(AUTONOMOUS)

NAAC Accredited Institution with 'A' Grade
Kandlakoya (V), Medchal Road, Hyderabad -501401.

01.12.2017

To
The Principal
CMRCET

Through: IQAC Coordinator

Sub: Permission to organize Engineering Cricket & Basket ball League Req. – Reg.

Respected Sir,

As per the approval from the IQAC for the sports events proposed to be conducted in the A.Y: 2017-18, the Sports & Games Committee will organize Engineering Cricket & Basket ball League in the month of December 2017 on every Saturday.

I request your kind approval for the Conduct of Inter Departmental Cricket and Basket Ball matches.

- Dates of the Events: 9th, 16th & 23rd, 30th of December, 2017.
- Name of the Events: Engineering Cricket & Basket ball League
- Importance: To bring out their hidden talents & to train them further.
To select them for college team, other university & National level.
- Venue: CMRCET Throw ball Court and Basket ball court.
- Target Audience: Students of respective department.
- Resources required: Play fields & playing Equipments.

Faculty members who are involved in the sports committee will be taking care of their respective department match & also the student members of the sports club will help the smooth conduction of the event.

Thanking you sir,

Recommended
Arcon
Coordinator
Internal Quality Assurance Cell
CMR College of Engineering & Technology
Kandlakoya (V), Medchal Road,
Hyderabad - 501 401.

Convener
Sports & Games Committee

Approved



CMR COLLEGE OF ENGINEERING & TECHNOLOGY

(AUTONOMOUS)

NAAC Accredited Institution with 'A' Grade
Kandlakoya (V), Medchal Road, Hyderabad -501401.

CMRCET/PRIN/ SPORTS/AY2017-18/CIR-06

Date: 04/12/2017

Sports & Games Circular

All the students are hereby informed that the Engineering Cricket & Basket ball League are scheduled in the month of December 2017 on every Saturdays. In this regards all the departmental Cricket and Basket ball teams should give your team entry by filling the entry form.

The following are the maximum number of players allowed from each department for the respective game mentioned below:

E V E N T S:

1. CRICKET 11 Players (11+5)
2. BASKET BALL 10 Players (5+5)
- a) Department team must submit the eligibility form of their players duly signed by HOD and sports in-charge of the respective department, the in-charge of particular department, must be present when their dept, team is playing the match without fail.
- b) All the entries should be sent to the Physical Director CMRCET by 6th December, 2017 before 2.00pm without fail. The fixtures and matches schedules will be displayed on notice board and circulated in all the sports groups on 7th December, 2017.
- c) All the matches will be on knock out basis.
- d) Sports /Discipline committee/Physical Director have right to disqualify any team or game in any circumstances.
- e) All the players must come in sports dress. Those players will be allowed for the matches.
- f) The matches will be held only on Saturdays.

Convener

Sports & Games Committee

Principal

Copy submitted to Secretary Garu for kind information

Copy to

- 1) HODs to kindly educate the students on the above and send the lists please
- 2) A.O
- 3) Sports Committee Members
- 4) To be read in the class room
- 5) Notice Board.



CMR COLLEGE OF ENGINEERING AND TECHNOLOGY
KANDLAKOYA, MEDCHAL, HYDERABAD 501401

**ENGINEERING
CRICKET &
BASKETBALL
LEAGUE**

**9, 16 & 23, 30
OF DECEMBER - 2017**

PRINCIPAL
CMR COLLEGE OF ENGG. & TECH.
Kandlakoya (V), Medchal Road,
Hyderabad-501401.



CMR COLLEGE OF ENGINEERING & TECHNOLOGY

(AUTONOMOUS)

NAAC Accredited Institution with 'A' Grade

Kandlakoya (V), Medchal Road, Hyderabad -501401.

Date: 05.12.2017

To,
Ch. Srisailam Reddy
Secretary & Correspondent
CMREC.

Sir,

Sub: Request to be Chief Guest of Engineering Cricket & Basket ball League - Reg.

CMR College of Engineering & Technology is Organizing Engineering Cricket & Basket ball League on 9th, 16th, 23rd, 30th December, 2017. It would be our great honor if you would grace the occasion as Chief Guest for the Engineering Cricket & Basket ball League on 9th December 2017 at 9:30 AM.

Thank you,

Major Dr.V.A.Narayana
Principal

PRINCIPAL
CMR COLLEGE OF ENGG. & TECH.
Kandlakoya (V), Medchal Road,
Hyderabad-501401.



CMR COLLEGE OF ENGINEERING & TECHNOLOGY
(AUTONOMOUS)

NAAC Accredited Institution with 'A' Grade
Kandlakoya(V), Medchal Road, Hyderabad - 501401.



CMR COLLEGE OF ENGINEERING & TECHNOLOGY
(AUTONOMOUS)

NAAC Accredited Institution with 'A' Grade
Kandlakoya(V), Medchal Road, Hyderabad - 501401.



EXPLORE TO INVENT

SPORTS INVITATION

To: _____

**"LIFE IS A CHESS GAME
.YOU DON'T WANT TO
WASTE A MOVE"**

PRINCIPAL
CMR COLLEGE OF ENGG. & TECH.
Kandlakoya(V), Medchal Road,
Hyderabad-501401.

Event Photos: Engineering Cricket & Basket ball League

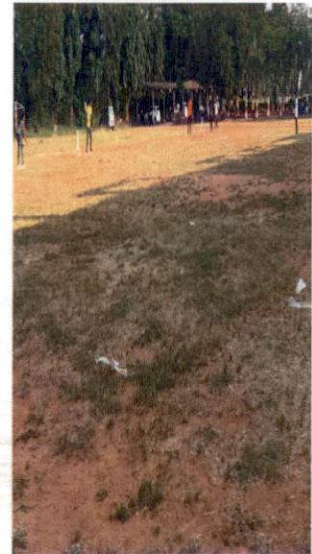

PRINCIPAL
CMF COLLEGE OF ENGG. & TECH.
Kandlakoya (V), Medchal Road,
Hyderabad-501401.

Event Report: Engineering Cricket & Basket ball League in the month of December 2017,

- Request letter to principal, to organize the Cricket and Basket ball events through IQAC Coordinator.
- Got the approval from Principal to organize the Cricket and Basket ball event during the month of January on Saturdays.
- Circular issued to students for the Cricket and Basket ball event and asked for entries.
- There were 6 teams who registered for each event.
- The Draws have been taken out in the presence of 5 committee members and the captains of various teams. Finally the result was CSE winners & CIVIL runners up in Cricket & ECE Winners & CSE runners in Basket ball.
- It is very much required for students to have physical activity once in a week, students involvement in academics is limited to writing MID Exam /Labs etc. in the week end there must be a recreation/any physical activity to come out of the stress in the end of the week.
- And also in the weekend the other students have enjoyed a lot by encouraging their department team. They also got relaxed after a week of stressful activity.
- The matches were conducted in the CMRCET Play Grounds.
- The resources from the college were only play fields & Playing Equipments.
- 8 students from Sports Club were involved in the event they made it success, and also the faculty of various departments was present when and where their department team is playing without any disturbance the event was completed.

Outcomes:

During these matches few students who are good at Cricket and Basket ball game skills got selected for further training & they can be sent for college team, other university & National level

Thanking you sir



**Convener
Sports & Games Committee**

CMR COLLEGE OF ENGINEERING AND TECHNOLOGY

MEDCHAL - 501401



FRESHERS DAY

Hidden talent search
for freshers



**LAST DATE FOR
Registration**

05 JAN 2018



CMR COLLEGE OF ENGINEERING & TECHNOLOGY
(AUTONOMOUS)

NAAC Accredited Institution with 'A' Grade
Kandlakoya (V), Medchal Road, Hyderabad -501401.

Date: 07.01.2017

To,
Sri Ch. Bhoopal Reddy
Vice Chairman
CMREC.

Sir,

Sub: Request to be Chief Guest of Hidden Talent Search In Freshers 2018- Reg.

CMR College of Engineering & Technology is Organizing Hidden Talent Search In Freshers 2018 on 10th, 12th January, 2018. It would be our great honor if you would grace the occasion as Chief Guest for the Hidden Talent Search In Freshers 2018 on 10th January 2018 at 9:30 AM.

Thank you,

Major Dr. V.A. Narayana
Principal

PRINCIPAL
CMR COLLEGE OF ENGG. & TECH.
Kandlakoya (V), Medchal Road,
Hyderabad-501401.

**DEPARTMENT OF
PHYSICAL EDUCATION**

Cordially Invites Your Gracious Presence
On The Occasion Of

**HIDDEN TALENT SEARCH
FOR FRESHERS 2018**

INAUGURAL FUNCTION

On
10TH JANUARY, 2018

Chief Guest

SRI CH. BHOOPAL REDDY,
VICE CHAIRMAN, CMREC

Venue: CMR Grounds

Programme Schedule

- 10:00 AM – INVITING THE GUESTS ON THE DAIS
- 10:05 AM – FLAG HOISTING
- 10:10 AM – VISITING TEAMS
- 10:15 AM – OATH TAKING
- 10:20 AM – ADDRESS BY MAJOR DR. V A NARAYANA ,
PRINCIPAL, CMRCET
- 10:25 AM – ADDRESS BY DR. M. JANGA REDDY,
PRINCIPAL, CMRIT
- 10:30 AM – ADDRESS BY DR. ABBULU , PRINCIPAL,
CMRCP
- 10:40 AM – ADDRESS BY SRI CH. SRISAILAM REDDY,
SECRETARY & CORRESPONDENT, CMREC
- 10:50 AM – ADDRESS BY SRI CH. BHOOPAL REDDY,
VICE CHAIRMAN, CMREC
- 10:55 AM – ADDRESS BY SRI CH. GOPAL REDDY,
SECRETARY & CORRESPONDENT,
CMRGI
- 11:05 AM – ADDRESS BY CHIEF GUEST
SRI CH. BHOOPAL REDDY,
VICE CHAIRMAN, CMREC
- 11:10 AM – DECLARING THE MEET OPEN
- 11:15 AM – VOTE OF THANKS

PRINCIPAL

CMR COLLEGE OF ENGG. & TECH.
Kandlakoya (V), Medchal Road,
Hyderabad-501401.

Event Photos: Hidden Talent Search in Freshers 2018



PRINCIPAL
CMR COLLEGE OF ENGG. & TECH.
Kandlakoya (V), Medchal Road,
Hyderabad-501401.

Event Report: Hidden Talent Search in Freshers 2018 in the month of January 2018,

- Request letter to the principal to organize the Hidden Talent Search in Freshers 2018 through IQAC Coordinator.
- Got the approval from Principal to organize the Hidden Talent Search in Freshers 2018 during the month of January.
- Circular issued to students for the Hidden Talent Search in Freshers 2018 and asked for entries.
- The Draws have been taken out in the presence of 3 committee members and the captains of various teams, and after the completion of matches results were declared.
- It is very much required for students to have physical activity once in a week. The Students' involvement in academics is limited to writing MID Exam's /Labs etc. During the week end there must be a recreation/any physical act.
- And also in the weekend the other students have enjoyed a lot by encouraging their department team. They also got relaxed after a week full of stress.
- The matches were conducted in CMRCET Grounds
- 8 students from Sports Club were involved in the event they made it success, and also the faculty of various departments was present when and where their department team is playing without any disturbance the event was completed.
- Prize distribution program held on Fresher's day.
- The budget Sanctioned for the tournament was Rs60,711 and the expenditure for the tournament is Rs 53,095 the account has been settled immediately after the tournament.

Outcomes:

During these matches few students who are good at various sports & games skills got selected for further training and they can be sent for college team, other university & National level

Thanking you sir



Convener

Sports & Games Committee



CMR COLLEGE OF ENGINEERING AND TECHNOLOGY

Kandlakoya Medchal Road, Hyderabad -501401

PHYSICAL EDUCATION DEPARTMENT

Approximate Expenditure

FRESHERS DAY 2017-18

TEAM CUPS

Winners Cups	9x650	5,850.00
Runners Cups	9x600	5,400.00

pay adv of Rs 45000/-

11/10/18

INDIVIDUAL CUPS

Winners Cups	106x150	15,900.00
Runners Cups	106x125	13,250.00

Reduce the cost

11,000/-

INDIVIDUAL EVENTS

Winners Cups	17x350	5,950.00
Runners Cups	17x300	5,100.00

TOTAL	51,450.00
CGST- 9%	4,630.50
SGST- 9%	4,630.50

Total

60,711.00

*B and Accounts
PO to purchase and
Coordinate with A/cb office
for payment
2) Accounts to do the
necessary payment*

PRINCIPAL
CMR COLLEGE OF ENGG. & TECH.
Kandlakoya (M), Medchal Road,
Hyderabad-501401.

Physical Director

pay adv of Rs. 45000/-



C.M.R. COLLEGE OF ENGINEERING & TECHNOLOGY

V.R. No.....

CASH PAYMENT

Dated 11/11/18 20

	AMOUNT	
	Rs.	Ps.
CREDIT		
Pay paid to Mr. Acharya for 10 Freshers day prizes	45000	
Rupees <u>Forty five thousand only</u>	45000	

Prepared by
[Signature]
11/11/18

Checked by

Receiver's Sign



PRINCIPAL
CMR COLLEGE OF ENGG. & TECH.
 Kandlakoya (V), Medchal Road,
 Hyderabad-501401.



DELIVERY CHALLAN

Ph : 27819834
27755408**ESS HANDICRAFTS**(GOVT. OF INDIA RECOGNIZED CRAFTSMEN'S SMALL SCALE UNIT)
Shop No. : 9 & 10 Cellar, Hardy Complex, M.G.Road, Secunderabad - 3.

TIN No. 28866220387

SSI UNIT No. 280061102310

Bill No.

M/s.

Principal CMR college of Engg & Tech

Date 10.1.18

Sl No.	PARTICULARS	Order Qty.	Issued Qty.	Rate	Amount
1.	Memento. Winnercy	9pc	9pc	650	5850-0
2	" Runnercy	9pc	9pc	600	5400-0
3	" Individual win	106	106	125	13250-0
4	" Runner	106	106	125	13250-0
5	" Individual Game win	17	17	250	4250-0
6	" Game Run	17	17	200	3400-0
					45,600
					CGS 18% 7695
					53,095

PRINCIPAL
CMR COLLEGE OF ENGG. & TECH.
Kandlakota (M), Medchal Road,
Hyderabad-501401.



CMR COLLEGE OF ENGINEERING & TECHNOLOGY

(AUTONOMOUS)

NAAC Accredited Institution with 'A' Grade
Kandlakoya (V), Medchal Road, Hyderabad -501401.

02.02.2018

To
The Principal
CMRCET

Through: IQAC Coordinator

Sub: Permission to organize Ultimate Kho Kho League Req. – Reg.

Respected Sir,

As per the approval from the IQAC for the sports events proposed to be conducted in the A.Y: 2017-18, the Sports & Games Committee will organize Ultimate Kho Kho League in the month of February 2018 on every Saturday. I request your kind approval to conduct the Ultimate Kho Kho League.

- Date/s of the Event: 10th, 17th, 24th of February, 2018.
- Name of the Event: Ultimate Kho Kho League
- Importance: To bring out their hidden talents & to train them further.
To select them for college team, other university & National level.
- Venue: CMRCET Kho Kho field.
- Target Audience: Students of respective department.
- Resources required: Play fields & playing Equipments.

Faculty members who are involved in the sports committee will be taking care of their respective department match & also the student members of the sports club will help the smooth conduct of the event.

Thanking you sir,

Recommended
Accepted
Coordinator
Internal Quality Assurance Cell
CMR College of Engineering & Technology
Kandlakoya (V), Medchal Road,
Hyderabad - 501 401.

Convener
Sports & Games Committee



CMR COLLEGE OF ENGINEERING & TECHNOLOGY

(AUTONOMOUS)

NAAC Accredited Institution with 'A' Grade
Kandlakoya (V), Medchal Road, Hyderabad -501401.

CMRCET/PRIN/ SPORTS/AY2017-18/CIR-08

Date: 05/02/2018

Sports & Games Circular

All the students are here by informed that, the Ultimate Kho Kho League are scheduled in the month of February 2018, on every Saturdays. In this regards all the departmental Kho Kho teams should give your team entry by filling the entry form.

The following are the maximum number of players allowed from each department for the respective game mentioned below:

E V E N T S:

1. KHO KHO 12 Players (9+3).
 - a) Department team must submit the eligibility form of their players duly signed by HOD and sports in-charge of the respective department, the in-charge of particular department, must be present when their dept, team is playing the match without fail.
 - b) All the entries should be sent to the Physical Director CMRCET by 7th February 2018 before 2.00 pm without fail. The fixtures and matches schedules will be displayed on notice board and circulated in all the sports groups on 9th February, 2018.
 - c) All the matches will be on knock out basis.
 - d) Sports /Discipline committee/Physical Director have right to disqualify any team or game in any circumstances.
 - e) All the players must come in proper dress, i.e., SHORT & T.SHIRT only. Those players will be allowed for the matches.
 - f) The matches will held only on Saturdays.



Convener

Sports & Games Committee



Principal

Copy submitted to Secretary Garu for kind information

Copy to

- 1) HODs to kindly educate the students on the above and send the lists please
- 2) A.O
- 3) Sports Committee members
- 4) To be read in the class room
- 5) Notice Board.

CMR COLLEGE OF ENGINEERING AND TECHNOLOGY

KANDLYAKOYA, MEDCHAL, HYDERABAD-501401



ULTIMATE KHO KHO LEAGUE

LAST DATE TO REGISTER: 7TH FEB, 2018

CONDUCTED ON: 10TH, 17TH & 24TH OF FEB, 2018

PRINCIPAL
CMR COLLEGE OF ENGG. & TECH.
Kandlyakoya (V), Medchal Road,
Hyderabad-501401.



CMR COLLEGE OF ENGINEERING & TECHNOLOGY

(AUTONOMOUS)

NAAC Accredited Institution with 'A' Grade
Kandlakoya (V), Medchal Road, Hyderabad -501401.

Date: 07.02.2018

To,
Sri Ch. Vasantha Latha Reddy
Seacretary &Correspondent
CMRTC.

Sir,

Sub: Request to be Chief Guest of Ultimate Kho Kho League 2018- Reg.

CMR College of Engineering & Technology is Organizing Ultimate Kho Kho League 2018 on 10th, 17th, 24th February, 2018. It would be our great honor if you would grace the occasion as Chief Guest for the Ultimate Kho Kho League on 10th February 2018 at 9:30 AM.

Thank you,

Major Dr.V.A.Narayana
Principal

PRINCIPAL
CMR COLLEGE OF ENGG. & TECH.
Kandlakoya (V), Medchal Road,
Hyderabad-501401.

DEPARTMENT C.
PHYSICAL EDUCATION

Cordially Invites Your Gracious Presence
On The Occasion Of

**ULTIMATE
KHO KHO LEAGUE 2018**

INAUGURAL FUNCTION

On
10TH FEBRUARY, 2018

Chief Guest
Smt.Ch.Vasantha Latha Reddy
Secretary & correspondent CMRTC

Venue: CMR Grounds

PRINCIPAL
CMR COLLEGE OF ENGG. & TECH.
Kandlakoya (V), Medchal Road,
Hyderabad-501401.

Programme Schedule

- 10:00 AM – INVITING THE GUESTS ON THE DAIS
- 10:05 AM – FLAG HOISTING
- 10:10 AM – VISITING TEAMS
- 10:15 AM – OATH TAKING
- 10:20 AM – ADDRESS BY MAJOR DR. V A NARAYANA ,
PRINCIPAL, CMRCET
- 10:25 AM – ADDRESS BY DR. M. JANGA REDDY,
PRINCIPAL, CMRIT
- 10:30 AM – ADDRESS BY DR. ABBULU , PRINCIPAL,
CMRCP
- 10:40 AM – ADDRESS BY SRI CH. SRISAILAM REDDY,
SECRETARY & CORRESPONDENT, CMREC
- 10:50 AM – ADDRESS BY SRI CH. BHOOPAL REDDY,
VICE CHAIRMAN, CMREC
- 10:55 AM – ADDRESS BY SRI CH. GOPAL REDDY,
SECRETARY & CORRESPONDENT,
CMRGI
- 11:05 AM – ADDRESS BY CHIEF GUEST,
Smt.Ch.Vasantha Latha Reddy
Secretary & correspondent CMRTC
- 11:10 AM – DECLARING THE MEET OPEN
- 11:15 AM – VOTE OF THANKS

Event Photos: Ultimate Kho Kho League



PRINCIPAL
CMR COLLEGE OF ENGG. & TECH.
Kandlakoya (V), Medchal Road,
Hyderabad-501401.

Event Report: Ultimate Kho Kho League in the month of February 2018,

- Request letter to principal to organize the Ultimate Kho Kho League through IQAC Coordinator.
- Got the approval from Principal to organize the Ultimate Kho Kho League during the month of February month on Saturdays.
- Circular issued to students for the Ultimate Kho Kho League and asked for entries.
- There were 6 teams who registered for this event.
- The Draws have been taken out in the presence of 3 committee members and the captains of various teams. Draws were like this,
 - i) CIVIL v/s MECH winner of these two teams played with ECE, ECE team has got bye.
 - ii) In the second half EEE v/s MBA winner of these two played with CSE, CSE team has got bye.
 - iii) Finally the result was CSE winners and CIVIL runners up.
- It is very much required for students to have physical activity once in a week, students involvement in academics is limited to writing MID Exam's /Labs etc. At the week end there must be a recreation/any physical activity to come out of the stress.
- And also in the weekend the other students have enjoyed a lot by encouraging their department team. They too got relaxed after a week stress.
- The matches were conducted in the Kho Kho Ground of CMRCET
- The resources from the college were only play fields.
- 8 students from Sports Club were involved in the event they made it success, and also the faculty of various departments was present when and where their department team is playing without any disturbance the event was completed.

Outcomes:

During these matches few students who are good at Kho Kho game skills got selected for further training and they can be sent for college team, other university & National level

Thanking you sir



Convener
Sports & Games Committee



CMR COLLEGE OF ENGINEERING & TECHNOLOGY

(AUTONOMOUS)

NAAC Accredited Institution with 'A' Grade
Kandlakoya (V), Medchal Road, Hyderabad -501401.

20/02/2018

To
The Principal
CMRCET

Through: IQAC Coordinator

Sub: Permission to organize JNTUH Zone 'C' and Central Zone Inter Engineering Collegiate Football Tournament – 2018– Reg.

Respected Sir,

As JNTUH Sports board is assigned to organize JNTUH Zone 'C' and Central Zone Inter Engineering Collegiate Football Tournament – 2018 in our college, the Sports & Games Committee would like to organize JNTUH Zone 'C' and Central zone Inter Engineering Collegiate Football Tournament from 24th to 27th March, 2018. I request you to grant permission to organize the above said tournament.

- Dates of the Event: 24th to 27th March, 2018.
- Name of the Event: Football.
- Importance: To get exposure to the outside games world
To get harmony & competitive spirit
To maintain cordial relation among players of various colleges
- Venue: CMRCET Football Grounds.
- Target Audience: Students of various colleges all over Telangana.
- Resources required: Play fields, Playing Equipments, Footballs, and Goal Nets, marking Powder, Corner Flags and Referees.
- Amount required: Rs1,18,500/-

Faculty members who are involved in the sports committee will be taking care of the matches and also the student members of the sports club will help for the smooth conduction of the tournament.

Thanking you sir,

Recommended
acom
Coordinator
Internal Quality Assurance Cell
CMR College of Engineering & Technology
Kandlakoya (V), Medchal Road,
Hyderabad - 501 401.

Convener
Sports & Games Committee

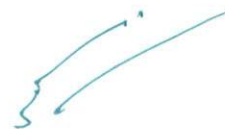



CMR COLLEGE OF ENGINEERING & TECHNOLOGY

Kandlakoya (V), Medchal Road, Hyderabad-501401

website: www.cmrct.org

Ph. No. 08418 - 224988, 260699 Mob: 9248727216

Chief Patron:

Sri Ch. Malla Reddy
Founder Chairman, CMRGI.

Patrons:

Sri Ch. Narasimha Reddy
Vice-Chairman, CMRGI.

Sri Ch. Bhoopal Reddy
Executive Member, CMRGI.

Sri Ch Srisailam Reddy
Executive Member, CMRGI.

President:

Sri Ch. Gopal Reddy
Secretary & Correspondent,
CMRGI.

Vice President

Dr.N Satyanarayana
Director, CMRGI

Organizing Committee:

Chairman:

Major Dr. V.A.Narayana
Principal, CMRCET.

Organizing Secretary:

Mr. Syed Rafeeq
Asst. Prof. in Phy. Edn.
98491 00278
92487 27216

Executive Members:

Mr. P.M.M. Reddy
Admin Officer

Mr. T.Mohan Rao
Asst. Prof. in Phy. Edn.
Cell: 9885545506

Mr. G. Shyam Sundar
PD, CMRCP.
Cell:9052000858

Mr. Y.Yugandar Reddy
P D, CMRTC
Cell: 9866564422

Mr. Rajesh Goud
P D, CMREC
Cell:9885832324

Mr Sridhar
PD, CMRTC

Date: 05.03.2018

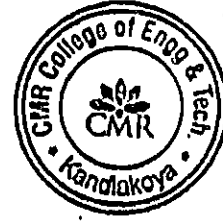

To
The Principals
JNTUH Affiliated colleges

Sir/Madam,

**Sub: JNTUH Zone "C" and Central Zone Foot Ball Tournament,
request for participation - Reg.**

We take pleasure in hosting the JNTUH Zone "C" and Central zone Foot Ball Tournament (for JNTUH Affiliated colleges under Zone "C") in our college and on this occasion we extend our cordial invitation to the principals of the Engineering and Pharmacy colleges under JNTUH Zone "C" Hyderabad to participate in the event.

We request for enthusiastic participation of your college team in the tournament to be organized from 24th to 27th March, 2018 at CMR COLLEGE OF ENGINEERING AND TECHNOLOGY, Medchal Road, Secunderabad. Last date of entries is 20th March, 2018. Kindly send the entries of your college team for participation in the tournament along with the entry fee of Rs. 800/- payable by Cash/DD Drawn in favour of Principal CMR College Engineering & Technology Payable at Hyderabad.

Once again we welcome your college team to participate in JNTUH Zone "C" and Central Zone Foot Ball Tournament 2018 and make it a grand success.

Note: No spot Registrations.

Thanking you,

Yours faithfully,

Principal

CMR COLLEGE OF ENGG. & TECH
Kandlakoya (V), Medchal Road,
Hyderabad-501401,



CMR COLLEGE OF ENGINEERING & TECHNOLOGY

Kandlakoya(V), Medchal Road, Hyderabad – 501401.

Ph.No. 08418 – 260699, Fax: 08418 – 224988.

JNTUH ZONE "C" AND CENTRAL ZONE FOOT BALL TOURNAMENT – 2018.

Rules and Regulations

- Students pursuing B. Tech, M. Tech, MBA and Pharmacy courses in the Engineering and Pharmacy colleges Affiliated JNTUH Under Zone "C".
- One team shall represent their respective college.
- The venue for conducting the tournament is CMR Group of Institutions located on NH 7, Kandlakoya, Medchal Road, Hyderabad. 501 401. Bus Route is 229 from Secunderabad to Medchal.
- Lunch, tea and snacks will be available at nominal rates.
- Unfurnished accommodation will be provided for outstation teams only on previous day of their match, on their request.
- Teams should be dressed in their college colour.
- Playing teams should be present on the specified ground at least 30 minutes before their match. Walk over will be given by the Referees if teams do not report on time.
- Players should be in the possession of valid ID cards issued by the respective college principal (no bonafide certificate/Hall Ticket will be accepted)
- Referees decisions are final and binding.
- The teams have to report for the inaugural function with their college flag on 23rd March, 2018 at sharp 9.30am, the team which fails to attend the function will not be allowed for the tournament.

Organizing Secretary



CMR College Of Engineering & Technology
Kandlakoya, Medchal, HYD.



JNTUH C-ZONE & CENTRAL ZONE
FOOTBALL CHAMPIONSHIP 2018
24th to 27th March 2018

last date of entry
20th march 2018



ORGANISING COMMITTEE CHAIRMAN:
MAJOR Dr. V.A. NARAYANA
Principal, CMRCET

ORGANISING HEAD:
SYED RAFEEQ
Physical Director, CMRCET,
9849100278, 9248727216

venue:-
CMRCET
medchal, Hyd.

ORGANISING COMMITTEE PRESIDENT:
CH.GOPAL REDDY
Secretary & Correspondent
CMR Group of Institutions

ORGANISING TEAM:
vamsi krishna-720726281
shravan kumar-81250582

CMR CO
Kandlakoya



CMR COLLEGE OF ENGINEERING & TECHNOLOGY

(AUTONOMOUS)

NAAC Accredited Institution with 'A' Grade
Kandlakoya (V), Medchal Road, Hyderabad -501401.

Date: 19.03.2018

To,
Sri. Ch. Malla Reddy
Member of Parliament.

Sir,

Sub: Request to be Chief Guest of JNTUH Zone 'C' and Central Zone Football
Tournament - Reg.

CMR College of Engineering & Technology is Organizing JNTUH Zone 'C' and Central
Zone INTER ENGINEERING COLLEGIATE FOOTBALL TOURNAMENT – 2018 from
24th to 27th March, 2018. It would be our great honor if you would grace the occasion as
Chief Guest for the JNTUH Zone 'C' and Central Zone Football Tournament on 24th March,
2018 at 9:30 AM.

Thank you,

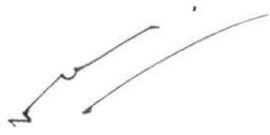
Major Dr. V.A. Narayana
Principal

PRINCIPAL
CMR COLLEGE OF ENGG. & TECH.
Kandlakoya (V), Medchal Road,
Hyderabad-501401.



CMR COLLEGE OF ENGINEERING & TECHNOLOGY

(AUTONOMOUS)

NAAC Accredited Institution with 'A' Grade
Kandlakoya (V), Medchal Road, Hyderabad -501401.

Date: 19.03.2018

To,
Sri. M. YEDUKONDALU
Former International Football Player
Superintendent Customs & GST.

Sir,

Sub: Request to be Guest of Honour of JNTUH Zone 'C' and Central Zone Football Tournament - Reg.

CMR College of Engineering & Technology is Organizing JNTUH Zone 'C' and Central Zone INTER ENGINEERING COLLEGIATE FOOTBALL TOURNAMENT – 2018 from 24th to 27th March, 2018. It would be our great honor if you would grace the occasion as Guest of Honour for the JNTUH Zone 'C' and Central Zone Football Tournament on 24th March, 2018 at 9:30 AM.

Thank you,

Major Dr. V.A. Narayana
Principal

PRINCIPAL
CMR COLLEGE OF ENGG. & TECH.
Kandlakoya (V), Medchal Road,
Hyderabad-501401.



CMR COLLEGE OF ENGINEERING & TECHNOLOGY

(AUTONOMOUS)

NAAC Accredited Institution with 'A' Grade
Kandlakoya (V), Medchal Road, Hyderabad -501401.

Date: 15th March, 2018

To
The Secretary
TFA Hyderabad.

Sub: Request for allotment of Officials for JNTUH ZONAL TOURNAMENT – Req.

Sir

The JNTUH Zone 'C' and Central Zone Foot Ball Tournament going to be held at CMR College of Engineering & Technology from 24th to 27th March, 2018. Hence I request you to kindly spare the services of TELANGANA FOOT BALL ASSOCIATION REFREES to conduct the said tournament and to take it a grand success.

Thanking you

Principal

Major Dr.V.A.Narayana
Principal

PRINCIPAL
CMR COLLEGE OF ENGG. & TECH.
Kandlakoya (V), Medchal Road,
Hyderabad-501401.

DEPARTMENT OF
PHYSICAL EDUCATION

Cordially Invites Your Gracious Presence
On The Occasion Of

**JNTUH C-ZONE
FOOTBALL
TOURNAMENT 2018**
INAUGURAL FUNCTION

On
24th March 2018 at 10:00 AM

Chief Guest

CH.MALLA REDDY
MP, MALKAJGIRI CONSTITUENCY & CHAIRMAN , CMRGI

Guest of Honour

M.YEDUKONDALU
FORMER INTERNATIONAL FOOTBALL PLAYER
& SUPERINTENDENT CUSTOMS & GST

Venue: CMR Grounds

Programme Schedule

- 10:00 AM – INVITING THE GUESTS ON THE DAIS
- 10:05 AM – FLAG HOISTING
- 10:10 AM – VISITING TEAMS
- 10:15 AM – OATH TAKING
- 10:20 AM – ADDRESS BY MAJOR DR. V A NARAYANA ,
PRINCIPAL, CMRCET
- 10:25 AM – ADDRESS BY DR. M. JANGA REDDY,
PRINCIPAL, CMRIT
- 10:30 AM – ADDRESS BY DR. ABBULU , PRINCIPAL,
CMRCP
- 10:40 AM – ADDRESS BY SRI CH. SRISAILAM REDDY,
SECRETARY & CORRESPONDENT, CMREC
- 10:50 AM – ADDRESS BY SRI CH. BHOOPAL REDDY,
VICE CHAIRMAN, CMREC
- 10:55 AM – ADDRESS BY SRI CH. GOPAL REDDY,
SECRETARY & CORRESPONDENT,
CMRGI
- 11:00 AM – ADDRESS BY GUEST OF HONOUR,
M.YEDUKONDALU
FORMER INTERNATIONAL FOOTBALL PLAYER,
SUPERINTENDENT CUSTOMS & GST
- 11:05 AM – ADDRESS BY CHIEF GUEST,
CH.MALLA REDDY
MP, MALKAJGIRI CONSTITUENCY
& CHAIRMAN , CMRGI
- 11:10 AM – DECLARING THE MEET OPEN
- 11:15 AM – VOTE OF THANKS

Event Photos: JNTUH Zone 'C' and Central Zone Football Tournament

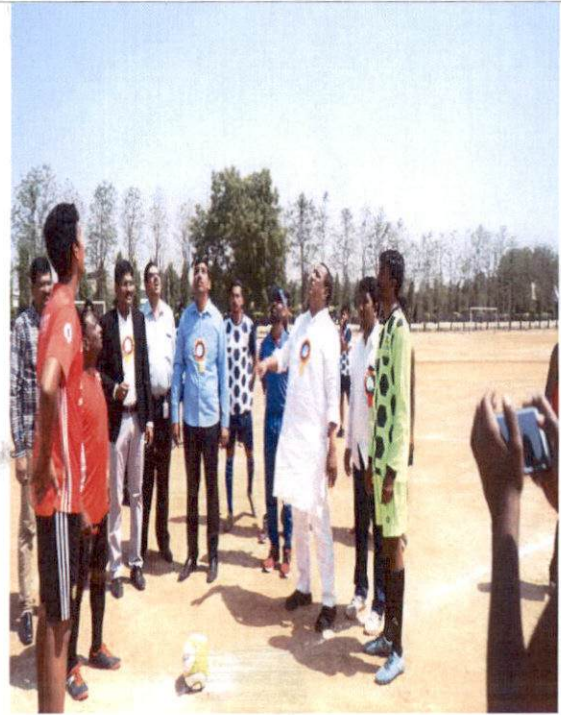

PRINCIPAL
CMR COLLEGE OF ENGG & TECH.
Kandlakoya (V), Medchal Road,
Hyderabad-501401.



PRINCIPAL
CMR COLLEGE OF ENGG. & TECH.
Kandlakota (V), Medchal Road,
Hyderabad-501401.

Event Report: JNTUH Zone 'C' and Central Zone Inter Engineering Collegiate Football Tournament in the month of March 2018,

- Request letter to principal to organize JNTUH Zone 'C' and Central Zone Inter Engineering Collegiate Football Tournament – 2018 through IQAC Coordinator. Got the approval from Principal to organize the Tournament from 24th to 27th March 2018.
- Invitation issued to various Engineering colleges of JNTUH Zone 'C' asking them for entries. Last date of entries was 20th March, 2018.
- There were 26 teams who registered for the tournament.
- The Draws have been taken out in the presence of all the officials, Physical Director and Captains of various colleges.
- The chief guest for the inaugural ceremony was Sri Ch. Malla Reddy, Member of Parliament.
- The Guest of Honour for the inaugural ceremony was Sri M. Yedukondalu, Former International Football player.
- Finally the Zone 'C' result was CMR College of Engineering and technology winner & St. Martins Engineering college was Runner up.
- And the Central Zone Winners are St.Martins Engineering College, Runners CMR College of Engineering and Technology.
- The matches were conducted in the Main Grounds of CMR College of Engineering & Technology
- Resource persons Referees from Telangana Football Association for smooth conduction of the tournament were invited.
- 10 students from Sports Club & 3 students from photography club were involved in The tournament and they made it grand success, and also the sports committee members of our college were present for this tournament.
- Closing ceremony, Prize distribution was held on 27th March, 2018, the chief guest for the function was Shri. Ch. Gopal Reddy , Secretary & Correspondent, CMRGI
- The budget sanctioned for the tournament was Rs. 1,18,500/- and the expenditure for the tournament was Rs. 1,16,206/- . The account has been settled immediately after the tournament.

Thanking you sir



Convener
Sports & Games Committee

**JNTUH ZONE "C" & CENTRAL ZONE FOOT BALL
TOURNAMENT - 2018**

Approximate estimation for the Tournament

1. Banners/Posters		Rs. 3,000/-
2. Prizes		Rs. 26,000/-
a) Winner Cups		
b) Runner Cups		
c) Individual Prizes		
d) Certificates		
3. Invitation for Colleges (Postal & Petrol)		Rs. 3,000/-
4. Inaugural Function		Rs. 4,000/-
a) Crackers		
b) Gas Balloons,		
c) Bouquet etc		
5. Umpires Remuneration (8 member x 4 days)		Rs. 42,000/-
6. Gifts for Officials (CMR Printed Bag/T-Shirt etc)		Rs. 15,000/-
7. Medical Kit		Rs. 500/-
8. Labour and white powder		Rs. 5,000/-
9. Lunch, Tiffin for Referees & Official		Rs. 10,000/-
10. Tent House		Rs. 10,000/-
	Total	Rs. 1,18,500/-
14. Team Entries (800x25)		Rs. 20,000/-
15. Team Entries (800x8)		Rs. 6,400/-
16. JNTUH Contribution		Rs. 20,000/-
Approximate Total		Rs. 72,100/-

pay 50,000/-

V. Srinivas 24/3/18

PRINCIPAL
CMR COLLEGE OF ENGG. & TECH.
Kandlakoya (V), Medchal Road,
Hyderabad-501401.

[Signature]
Physical Director

A. O. Rs 25,000 Advance.

Recommended and honored

Journal. C. Srinivas 23/3/18 To Accts pay Adv Rs 50,000/- C. Srinivas 23/3/18

pay 25,000/- V. Srinivas 23/3/18



CMR COLLEGE OF ENGINEERING AND TECHNOLOGY

Kandlakoya (V), Medchal Road, Hyderabad-501401.

Ph. No. 08418 - 329342, 224988, 260699 Mob: 9247605108

JNTUH ZONE "C" & CENTRAL ZONE FOOT BALL TOURNAMENT - 2018

Approximate estimation for the Tournament

	Approx Amount	Actual Amount
1. Banners/Posters	Rs. 3,000/-	2,400.00 ✓
2. Prizes	Rs. 26,000/-	27,104.00 ✓
a) Winner Cups		
b) Runner Cups		
c) Individual Prizes		
d) Certificates		
3. Invitation for Colleges (Postal & Petrol)	Rs. 3,000/-	2,210.00 ✓
4. Inaugural Function	Rs. 4,000/-	4,000.00 ✓
a) Crackers		
b) Gas Balloons,		
c) Bouquet etc		
5. Umpires Remuneration (8 member x 4 days)	Rs. 42,000/-	36,400.00 ✗
6. Gifts for Officials (CMR Printed Bag/T-Shirt etc)	Rs. 15,000/-	15,000.00 ✓
7. Medical Kit	Rs. 500/-	607.00 ✓
8. Labour and white powder	Rs. 5,000/-	4,600.00 ✓
9. Lunch, Tiffin for Referees & Official	Rs. 10,000/-	11,985.00 ✓
10. Tent House	Rs. 10,000/-	11,900.00 ✓
Total	Rs. 1, 18,500/-	1,16,206.00 ✓
14. Team Entries (800x25)	Rs. 20,000/- Adv	25,000.00
15. Team Entries (800x8)	Rs. 6,400/- -	50,000.00
16. JNTUH Contribution	Rs. 20,000/- .Fee	12,000.00
Approximate Total	Rs. 72,100/-	29,206.00 ✓

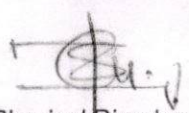
Physical Director

PRINCIPAL
CMR COLLEGE OF ENGG. & TECH.
Kandlakoya (V), Medchal Road,
Hyderabad-501401.



C.M.R. COLLEGE OF ENGINEERING & TECHNOLOGY

10/10
2nd floor

VR. No.

CASH PAYMENT

Dated 7/4/20

	AMOUNT	
	Rs.	Ps.
CREDIT		
Can paid to Mr. S. S. S. PD		
of W. Foot Ball Tournament		
Balance amount	29,206	
Rupees	Twenty nine thousand two hundred	
	29,206/-	

Prepared by
[Signature]

Checked by
[Signature]

Receiver's Signai



PRINCIPAL
CMR COLLEGE OF ENGG. & TECH.
Kandlakoya (V), Medchal Road,
Hyderabad-501401.

TAX INVOICE

GSTIN NO.: 36AABFE8927D1Z1

BILL No. 2418

Date: 02-04-2018

CASH / CREDIT CARDS / BANK



ESS HANDICRAFTS

(SSI UNIT No. 280061102310 A Govt. Of India Recognized Craftmen's Small Scale Unit)
 Shop No. 9 & 10, Cellar, Hardy Complex, M.G. Road, Secunderabad - 500 003. TELANGANA.
 Ph : 040-27819834/33, 040-27755405
 E-mail : esshandicrafts27819834@gmail.com , esshandicrafts_hyd@yahoo.co.in
 Works : Hasmatpet, Secunderabad.

To: The principal,
 CMR college of Engineering &
 Technology.

Buyer's GSTIN No: _____

Buyer's Telephone No. 9248727216

D.C. No.

No. Of Pkgs.

Sl. No.	PARTICULARS / DESCRIPTION	HNS Code	Qty.	Rate	Amount
1	s/moments winner cup	8306	2p	3500/-	7000 -
2	runner cup	4	2p	3000/-	6000 -
3	Individual Runner	4	36p	95/-	3420 -
4	Individual Winner	4	36p	105/-	3780 -
5	Certificate	4	500p	8/-	4000 -
Sub Total					24200 -
TAX @ 12%					
Central Tax (GST)					6% 1452 -
State Tax (SGST)					6% 1452 -
TOTAL					✓ 27104 -

E & O.E.

Rupees in words: Twenty Seven thousand One Hundred

For ESS HANDICRAFTS

Bank Details : ANDHRA BANK, M.G. Road, Secunderabad.

A/c No. 036213046002460 • IFSC Code : ANDB0000362

Authorised Signatory

PRINCIPAL
 CMR COLLEGE OF ENGG. & TECH.
 Kandlakoya (V), Medchal Road,
 Hyderabad-501401

CASH / CREDIT BILL

SREE SAI BALAJI DIGITALS

FLEX & BANNERS

Email : sreesaibalajidigitals@gmail.com

Cell : 9849967775, 9000241031

Plot No.9&10, N.G.O.'s Colony, NH-44, Medchal, R.R Dist - 501401

SSB DIGITALS
MEDCHAL
9849967775

To **CMR C&T**

SI. No **537**

Date: **10/3/18**

Sl. No.	PARTICULARS	Size	Qty	Sft	Rate Per Sft	Amount Rs.	Ps.
01	Platz Banner	6x4	2			600	
TOTAL						600	

Designing Charges..... Advanced Paid.....
Looping Charges..... Balance Due.....
Customer's Signature

For Sree Sai Balaji Digital

Nash

Signature

PRINCIPAL
E OF ENGG & TECH.
(M), Medchal Road,
Hydrabad-501401.

APPA RAO

ONLINE DIGITAL SOLUTIONS

7416345883
9010313085

Medipally, Hyderabad

harshnidigitals2016@gmail.com

CASH BILL

No. 651

Date: 13/8/18

M/s CMR college of Engg & Tech

S.No.	Particulars	Qty.	Rate	Amount	
				Rs.	Ps.
1.	poster (13x19) screen	40 nos	20/-	800-00	
				/	
				800-00	

Thank Q Visit Again

Appa Rao
Kannur

PRINCIPAL
COLLEGE OF ENGG & TECH
Kannur (V), Medchal Road,
Hyderabad-501401.

CASH / CREDIT BILL

SREE SAI BALAJI DIGITALS

FLEX & BANNERS

Email : sreesaibalajidigitals@gmail.com

Cell : 9849967775, 9000241031

Plot No 9&10, N GO 's Colony, NH-44, Medchal, R.R. Dist - 501401

SRI DIGITALS
MEDICAL
9849967775

To
Sri **CMR C&T**

Sl. No. **553**

Date **23/03/18**

Sl. No.	PARTICULARS	Size	Qty	Sft	Rate Per Sft	Amount Rs.	Ps.
01	flex Banner	6x4 8x4	1 1	3		700	
TOTAL						700	

Designing Charges..... Advanced Paid

Looping Charges..... Balance Due

Customer's Signature

For Sree Sai Balaji Digital

PRINCIPAL
OF ENGG. & TECH.
(V), Medchal Road,
Hyderabad-501401.

Narek
Signature

SRI CHILIKURI BALAJI CATERING SERVICES

Sri Ganesh Nilayam, Plot No. 4, Chanda Nagar,
MEDCHAL, Ranga Reddy Dist. Pin : 501 401

No. 487

Date : 25/3/2018

M/s. *Sri Chilikuri Balaji*

Sl. No.	PARTICULARS	QTY.	RATE	AMOUNT	
				Rs.	Ps.
6	<i>curry</i>	60	50	3,000	
	<i>spices</i>	10 75	15	225	
			TOTAL	3,225	

*5760
3225*

[Handwritten signature]

Rs.in words :

CMR
K...

PRINCIPAL
COLLEGE OF ENGG. & TECH.
(V), Medchal Road,
Hyderabad-501401.

Thank you

For Sri Chilikuri Balaji Catering Services

Signature

CASH / CREDIT BILL

SREE SAI BALAJI DIGITALS FLEX & BANNERS

Email : sreesaibalajidigitals@gmail.com

Cell : 9849967775, 9000241031

Plot No.9&10, N.G.O's Colony, NH-44, Medchal, R.R.Dist - 501401

SSB DIGITALS
MEDCHAL
9849967775

To Sri CMR LGT

Sl. No. 561

Date: 26/3/18

Sl. No.	PARTICULARS	Size	Qty	Sft	Rate Per	Amount	
					Sft	Rs.	Ps.
①	Flex Banner	6x4	1			300	
TOTAL						300	

Designing Charges..... Advanced Paid.....
Looping Charges..... Balance Due.....
Customer's Signature.....

For Sree Sai Balaji Digital

Narsh
Signature

PRINCIPAL
OF ENGG. & TECH.
(P), Medchal Road,
Medchal-501401.

CASH BILL

9908007351
9618813069



RAMDEV

ELECTRICAL, HARDWARE, PAINTS & SANITARY
N.H., 44, L.R. Complex, Near Satya Sai Petrol Pump, Medchal,
R.R. Dist. Hyderabad - 501401.

We CMR College Date 23-3-18

PARTICULARS	Qty.	Rate	Amount
white powder	4	35	1400-00
TOTAL			1400-00

PRINCIPAL
CMR COLLEGE OF ENGG. & TECH.
Kam... (M) Medchal Road,
Hyderabad-501401.

Prop.

ALHAMDU LILLAH PHOOL MAHAL

We undertake all kinds of Parties Packages
Spl. In : FLOWER & CALCUTTA DECORATORS

Opp. 'X' Roads, New Bowenpally, Secunderabad - 11. T.S

Cell : 9246526610, 9393655550

☎ : 040-27754259, 9966555510.

Date... 23/3/18

6 Bqm @ 300 1800

1800

1000 - 0

PRINCIPAL
OF ENGG. & TECH.
(M), Medchal Road,
Hyderabad-501401.

EMF
Kind



A TO Z. BAGS WORKS

8019591021

Mfg. of : SKY BAGS & TRAVELLING GOODS

Spl. in : COMPLEMENT ITEMS

14-1-74, SITARAMPET, MANGALHAT, HYDERABAD.

No. 25
M/s

Date 05/5/18

Principal - CRPR college, Jaitapally

S.No	PARTICULARS	Qty.	Rate	AMOUNT	
				Rs.	P.
	Travel Bag	50	300	15,000	
TOTAL				15,000	

PRINCIPAL
 CMF COLLEGE OF ENGG. & TECH.
 (V), Medchal Road,
 Hyderabad-501401.

Receiver's Signature

Alauddin
For A to Z. Bags Works

SRI CHILIKURI BALAJI CATERING SERVICES

Sri Ganesh Nilayam, Plot No. 4, Chanda Nagar,
MEDCHAL, Ranga Reddy Dist. Pin : 501 401

No. **487**

Date : **25/3/2018**

M/s. *Sri Ganesh Nilayam*

Date	PARTICULARS	QTY.	RATE	AMOUNT	
				Rs.	Ps.
6	<i>lamb</i>	60	50	3,000	
	<i>spiced</i>	10 75	15	225	
				TOTAL	3,225

3760
3225

Rs.in words :

Thank you

For Sri Chilikuri Balaji Catering Services

Signature

PRINCIPAL
CMR COLLEGE OF ENGG. & TECH.
 No. 1 (V), Medchal Road,
 Hyderabad-501401.

1	30/10		
2	24/10	Tel	1
3		Chankis	15
4		Scrine Parake	2
5		Green Mat	9
6			5000
7			
8		Transfr	200
9			5200
10			
11			
12			
13			
14			
15			
16			
17			
18			
19			
20			
21			
22			

PRINCIPAL
 DEPT OF ENGG. & TECH.
 (V), Medchal Road,
 Kancharla, Hyderabad-501401.

2	50/10 = 5		
3	Character		
4	Scrine Parake	2	600
5			<u>9100</u>
6			X3
7			630
8			400
9	Ar		<u>6700</u>
10			
11			
12			
13			
14			
15			
16			
17			
18			
19			
20			
21			

 PRINCIPAL
 CMR COLLEGE OF ENGG. & TECH.
 Kanchi (V), Medchal Road,
 Hyderabad-501401.

RAVI CATERERS



13-155, Ragavendra Nagar Colony, Medchal
Ph: 9885475408

No: 053 Com. R. CET Foot BALL QTL

Sl.No:	Description	Qty	Rate	Amount
1	Tiffin	120	20	2400
2	Lunch	120	45	5400
3	Tea	60	6	360
4	Cooldrink	30	20	600
TOTAL				8760

[Handwritten signature]

PRINCIPAL
CMR COLLEGE OF ENGG. & TECH.
Kandlakota (V), Medchal Road,
Hyderabad-501401.



Cell : 9948142312
9177311666

SRI CHILUKURI BALAJI CATERING SERVICES

Plot No.4, Sri Ganesh Nilayam, Venkata Ramaiah Colony,
Medchal, Medchal Dist. - 501 401.

Website: www.chilukuribalajicatering.com, E-mail : nvsreddy1122@gmail.com

No.

Date : 28-2-18

M/s. Principal CMR College of Engineering & Tech

Date	PARTICULARS	Qty.	RATE	AMOUNT	
				Rs.	Ps.
1.	Meals & Snacks			4992	00
TOTAL				4992	00

Rs. in words : Four thousand Nine hundred only

Thank you Wso

For Sri Chilukuri Balaji Catering Services

Signature

PRINCIPAL
CMR COLLEGE OF ENGG. & TECH.
Kandlakota (M), Medchal Road,
Hyderabad-501401.



C.M.R. COLLEGE OF ENGINEERING & TECHNOLOGY

V.R. No.....

CASH PAYMENT

Dated 28.3.18.....20

	AMOUNT	
	Rs.	Ps.
CREDIT		
Cash Paid to Mr Hashim Saib		
Keywords Post Bill Dammam	36400	00
Rupees	36400	00

Prepared by

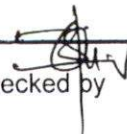
Checked by 

Receiver's Signature 

PRINCIPAL
CMR COLLEGE OF ENGG. & TECH.
Kandlakoya (V), Medchal Road,
Hyderabad-501401.



CMR COLLEGE OF ENGINEERING & TECHNOLOGY

(AUTONOMOUS)

NAAC Accredited Institution with 'A' Grade
Kandlakoya (V), Medchal Road, Hyderabad -501401.

17.03.2018

To
The Principal
CMRCET

Through: IQAC Coordinator

Sub: Permission to organize Annual day Sports Req. – Reg.

Respected Sir,

As per the approval from the IQAC for the sports events proposed to be conducted in the A.Y: 2017-18, the Sports & Games Committee would like to organize Annual day Sports in the month of March 2018. I request your kind approval to conduct the Annual day Sports Matches.

- Dates of the Events: 26th to 30th March 2018.
- Name of the Event: Annual day sports.
- Importance: Sports reduces pressure and stress
Sports lead to a well balanced mental and physical growth and tones up muscles, and strengthens bones
It also helps to improve their academic level and makes them alert & attentive
- Venue: CMRCET Play Grounds.
- Target Audience: Students of respective department.
- Resources required: Play fields, Playing Equipments, Marking Powder and Photography Club Members.
- Amount required: Rs. 2,31,500/-

Faculty members who are involved in the sports committee will be taking care of their respective department match & also the student members of the sports club will help the smooth conduct of the event.

Thanking you sir,

Recommended
hcon
Coordinator
Internal Quality Assurance Cell
CMR College of Engineering & Technology
Kandlakoya (V), Medchal Road,
Hyderabad - 501 401.

Convener
Sports & Games Committee



CMR COLLEGE OF ENGINEERING & TECHNOLOGY

(AUTONOMOUS)

NAAC Accredited Institution with 'A' Grade

Kandlakoya (V), Medchal Road, Hyderabad -501401.

CMRCET/PRIN/ SPORTS/AY2017-18/CIR-09

Date: 04/01/2018

Sports & Games Circular

All the students are hereby informed that, there will be Inter Departmental Tournament on the occasion of **SPORTS DAY CELEBRATIONS on 31st March, 2018**, and the Matches will be from 26th March 2018 onwards for B.Tech and M.B.A students in various games such as **Cricket, Foot Ball, Basket Ball, Volley Ball, Throw Ball, Kabaddi, Kho – Kho, Tennicoit, Table Tennis** for boys and girls.

The following are the maximum number of players allowed from each department for the respective games mentioned below:

E V E N T S:

1. CRICKET	-	15 Players (11+4)
2. BASKET BALL	-	10 Players (5+5)
3. VOLLEY BALL	-	10 Players (6+4)
4. FOOT BALL	-	15 Players (11+4)
5. THROW BALL (W)	-	12 Players (7+5)
6. KHO – KHO (M/W)	-	12 Players (9+3)
7. KABADDI (M/W)	-	10 Players (7+3)
8. TENNICOIT (W)	-	8 Players from ECE & CSE 4 from other Depts.
9. TABLE TENNIS (M/W)	-	8 Players from ECE & CSE 4 from other Depts.
10. CARROMS (M/W)	-	8 Players from ECE & CSE 4 from other Depts.
11. CHESS (M/W)	-	4 Players from ECE & CSE 2 from other Depts.

- Department teams must submit the eligibility form of their players duly signed by HOD and sports in-charge of the respective department.
- All the entries should be sent to the Physical Director CMRCET by 23rd March 2018 before 2.00pm without fail. Fixtures (Draws) will be taken out on 24th March, 2018 at 3.00pm
- All the matches will be on knock out basis
- HODS/In-charges are requested to ensure that no student is entertained for more than one game as there may be matches for same dept simultaneously in different games
- Sports/Discipline committee/Physical Director have right to disqualify any team or game in any circumstances
- All the players must come in proper dress, i.e., SHORT & T.SHIRT only. Those players will be allowed for the matches.
- All the concern Heads please inform your department team Captains to report on 23/03/2018 at 3.00 pm sharp. Draws will be taken out in the presence of all, match dates also be given on the same day.

Convener

Sports & Games Committee

Principal

Copy submitted to Secretary Garu for kind information:

Copy to

- 1) HODs-to kindly educate the students on the above and send the lists please
- 2) A.O
- 3) to be read in the class room
- 4) Notice Board



CMR COLLEGE OF ENGINEERING AND TECHNOLOGY ANNUAL DAY SPORTS



**FROM
26TH MARCH 2018**

**LAST DATE FOR
REGISTRATION
23RD MARCH 2018**

PRINCIPAL
CMR COLLEGE OF ENGG. & TECH.
Kandlakoya (V), Medchal Road,
Hyderabad-501401.



CMR COLLEGE OF ENGINEERING & TECHNOLOGY

(AUTONOMOUS)

NAAC Accredited Institution with 'A' Grade
Kandlakoya (V), Medchal Road, Hyderabad -501401.

Date: 26.03.2018

To,
Dr. V. Satyanarayana
Sports Board Secretary,
Kakatiya University,
Warangal.

Sir,

Sub: Request to be Chief Guest of Annual Sports Day celebrations-2018 - Reg.

CMR College of Engineering & Technology is Celebrating Annual Sports Day -2018 on 31st, March 2018. It would be our great honor if you would grace the occasion as Chief Guest for the Annual Sports Day -2018, on 31st March, 2018 at 2:00 PM.

Thank you,

Major Dr. V .A. Narayana
Principal

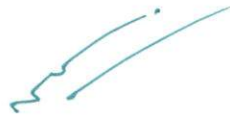
PRINCIPAL
CMR COLLEGE OF ENGG. & TECH.
Kandlakoya (V), Medchal Road,
Hyderabad-501401.

DEPARTMENT C.
PHYSICAL EDUCATION

Cordially Invites Your Gracious Presence
On The Occasion Of

ANNUAL DAY
SPORTS

On
26TH MARCH, 2018

Chief Guest
DR. V. SATYANARAYANA

SPORTS BOARD SECRETARY, KAKATIYA UNIVERSITY,
WARANGAL.

Venue: CMR Grounds

Programme Schedule

- 10:00 AM – INVITING THE GUESTS ON THE DAIS
- 10:05 AM – FLAG HOISTING
- 10:10 AM – VISITING TEAMS
- 10:15 AM – OATH TAKING
- 10:20 AM – ADDRESS BY MAJOR DR. V A NARAYANA ,
PRINCIPAL, CMRCET
- 10:25 AM – ADDRESS BY DR. M. JANGA REDDY,
PRINCIPAL, CMRIT
- 10:30 AM – ADDRESS BY DR. ABBULU , PRINCIPAL,
CMRCP
- 10:40 AM – ADDRESS BY SRI CH. SRISAILAM REDDY,
SECRETARY & CORRESPONDENT, CMREC
- 10:50 AM – ADDRESS BY SRI CH. BHOOPAL REDDY,
VICE CHAIRMAN, CMREC
- 10:55 AM – ADDRESS BY SRI CH. GOPAL REDDY,
SECRETARY & CORRESPONDENT,
CMRGI
- 11:05 AM – ADDRESS BY CHIEF GUEST,
DR.V.SATYANARAYANA
PRINCIPAL
CMR COLLEGE OF ENGG. & TECH.
Kandlakoya (V), Medchal Road,
Hyderabad-501401.
- 11:10 AM – DECLARING THE MEET OPEN
- 11:15 AM – VOTE OF THANKS

PROGRAMME SCHEDULE

- 2:00 pm: Inviting the guests on the dais
- 2:05 pm: Address by Physical Director Mr Syed Rafeeq
- 2:10 pm: Address by Major Dr. V A Narayana
Principal, CMRCET
- 2:15 pm: Address by Dr. M Janga Reddy
Director, CMRIT
- 2:20 pm: Address by Dr. Abbulu
Principal, CMRCP
- 2:30 pm: Address by Sri. Ch. Srisailam Reddy
Secretary and Correspondent, CMREC
- 2:35 pm: Address by Sri. Ch. Bhoopal Reddy
Vice Chairman, CMREC
- 2:40 pm: Address by Sri. Ch. Gopal Reddy
Secretary and Correspondent, CMRGI
- 2:50 pm: Address by Chief Guest, **Dr.V.Satyanarayana**
Sports Board Secretary
Kakatiya University, Warangal
- 2:55 pm: Prize Distribution-
- Prizes to Achievers
- Prizes to University Players
- Gifts to HODs
- Inter Branch Prizes
- Felicitation of Chief Guest and Guest of Honour
- 3:00 pm: Vote of Thanks



CMR COLLEGE OF ENGINEERING & TECHNOLOGY

(AUTONOMOUS)

NAAC Accredited Institution with 'A' Grade
Kandlakoya (V), Medchal Road, Hyderabad -501401.

SPORTS & GAMES COMMITTEE

ANNUAL DAY CELEBRATIONS 2018.

RESULTS

<u>EVENT</u>	<u>WINNERS</u>	<u>RUNNER UP</u>
1. FOOT BALL	EEE	CSE
2. VOLLEY BALL	ECE	EEE
3. BASKET BALL	MECH	CSE
4. CRICKET	CIVIL	EEE
5. THROW BALL (W)	ECE	CSE
6. KHO – KHO (M)	EEE	CIVIL
7. KHO – KHO (W)	CSE	ECE
8. KABADDI (M)	MECH	EEE
9. KABADDI(W)	ECE	CSE
10. STAFF CRICKET	ECE-SURESH RAM	CIVIL-SURESH
11. STAFF THROW BALL	CSE - SRIVANI	H& S - LAXMI
12. STAFF CRICKET (W)	-----	-----
13. TENNICOIT (Singles) I (17H51A03A7)	I st Place	AKSHAYA MECH
	II nd Place (17H51A02A0)	MADHAVI EEE I
14. TENNICOIT (Doubles) CSE	I st Place	G.HARIKA/SUSHMITHA
	II nd Place EEE	MADHAVI/BHARATHI
15. TABLE TENNIS (W) (Singles)	Ist Place	-----
	II nd Place	-----
16. TABLE TENNIS (W) (Doubles)	Ist Place-	-----
	II nd Place -	-----
17. TABLE TENNIS (M) (Singles)	Ist Place-	GIRDHAR CSE IV
		II nd Place-
		KALYAN CSE III
18. TABLE TENNIS (M) (Doubles) III/SNEHITH CSE I	Ist Place –	KALYAN CSE

- | | | | |
|-----------------------------|-----------------------|-------------------------|------|
| | IInd Place- | ADITYA EEE | |
| | IV/SIDDHARTH EEE IV | | |
| 19. CARROMS (W) (Singles) | Ist Place- | G.SOWMYA (| |
| 7799277676) | | | |
| | IInd Place - | P.SAI SAMYUKTHA | |
| | (9849372765) | | |
| 20. CARROMS (W) (Doubles) | Ist Place- | V.SAI | |
| KEERTHANA/G.SOWMYA | | | |
| | | (9059474814/7799277676) | |
| | IInd Place- | P.SAI | |
| | SAMYUKTHA/B.SUDEEPTHI | | |
| | | (9849372765/9866886175) | |
| 21. CARROMS (M) (Singles) | Ist Place | D.SHIVA | |
| RAMAKRISHNA (9573750414) | | | IInd |
| Place - SANJAY (9030056245) | | | |
| 22. CARROMS (M) (Doubles) | Ist Place- | SANJAY/HARSH | |
| (9030056245) | | | |
| | IInd Place- | ANURAG/RAJESH | |
| | (8106710042) | | |
| 23. CHESS (M) - | Ist Place | K.VIKRAM(9912019847) | |
| | IInd Place | D.VISHAL (8897824816) | |
| 24. CHESS(W) | Ist Place | V.SAI KEERTHANA | |
| (9059474814) | | | |
| | IInd Place | G.SOWMYA (7799277676) | |



Convener

Sports & Games Committee

Annual day Sports & Games 2018

CRICKET FIXTURES

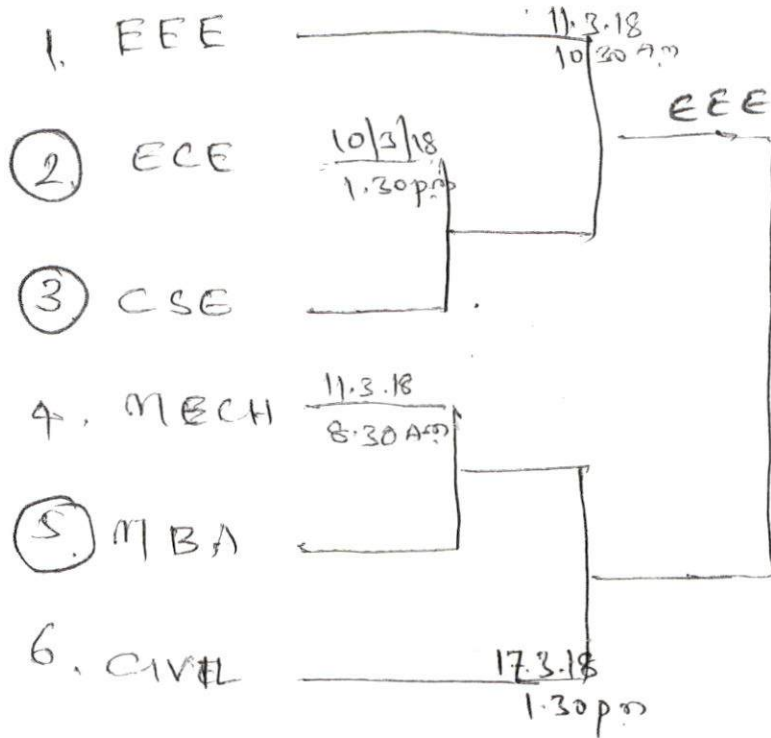

1. Syed Refeeq P.O.
2. B. Suresh Ram
3. K. Bhanu Prakash Reddy's (MBA) 9542903836
4. S. Sai Charan (CSE)
5. D. Sai Chandra (CIVIL)
6. L. Vamchidhar Reddy (ECE)
7. K. Suraj Reddy (MECH)

PRINCIPAL
CMR COLLEGE OF ENGG. & TECH.
Kandlakoya (V), Medchal Road,
Hyderabad-501401.

08/3/18

Staff Cricket fixtures

Men

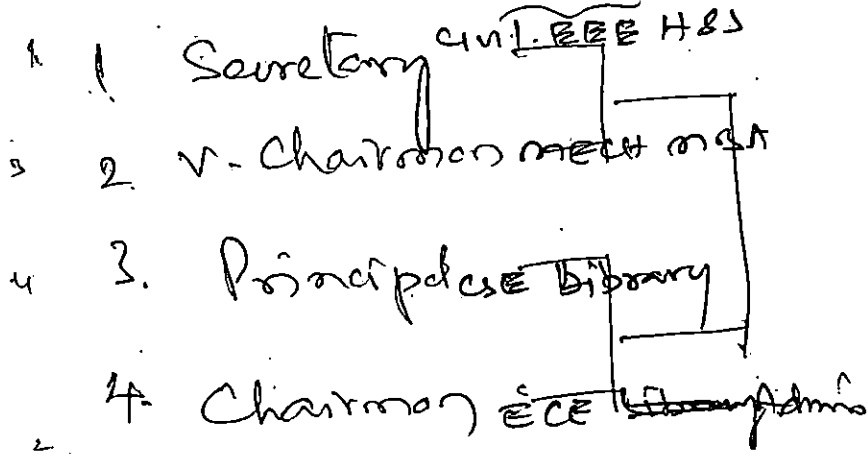

Staff ~~Cricket~~ Fixture

Women

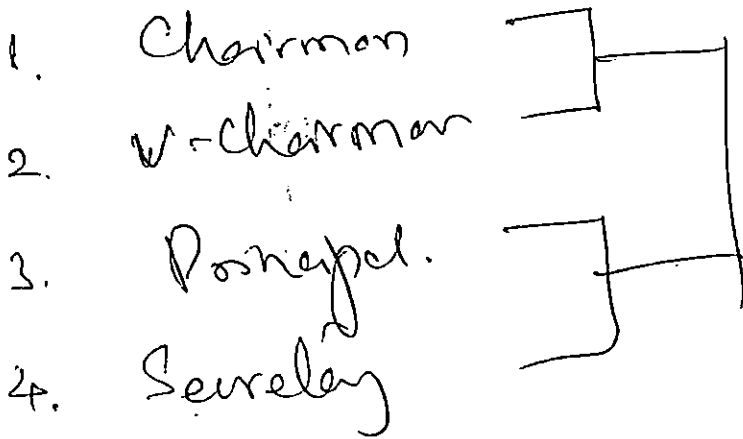

1. (A) (HOD ECE)

2. (B) (HOD EEE)

3.

4.

5.

(C) (HOD)

(D) (HOD-ECE)

Annual Day Matches on 25.3.18
VOLLEY BALL

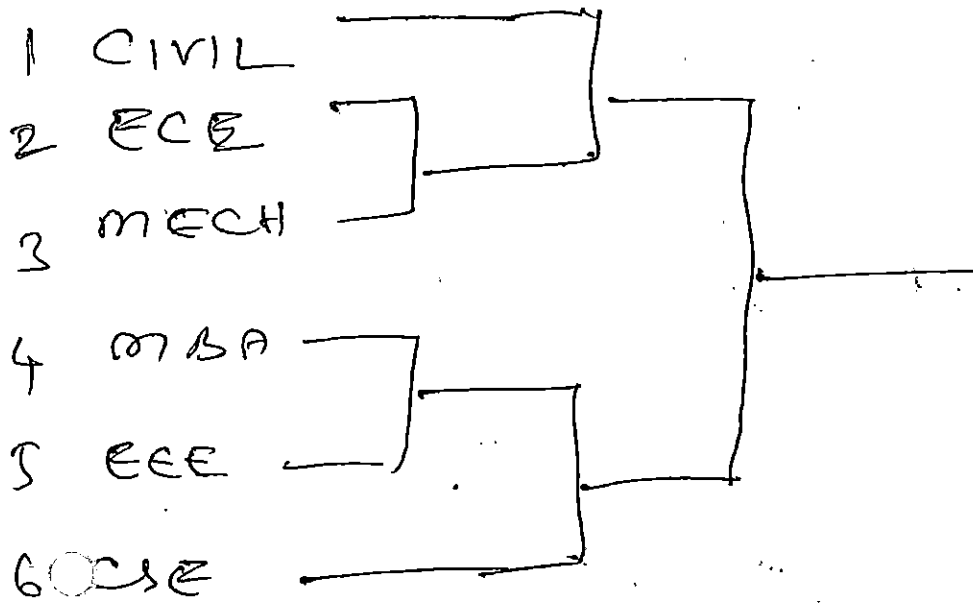

BASKET BALL

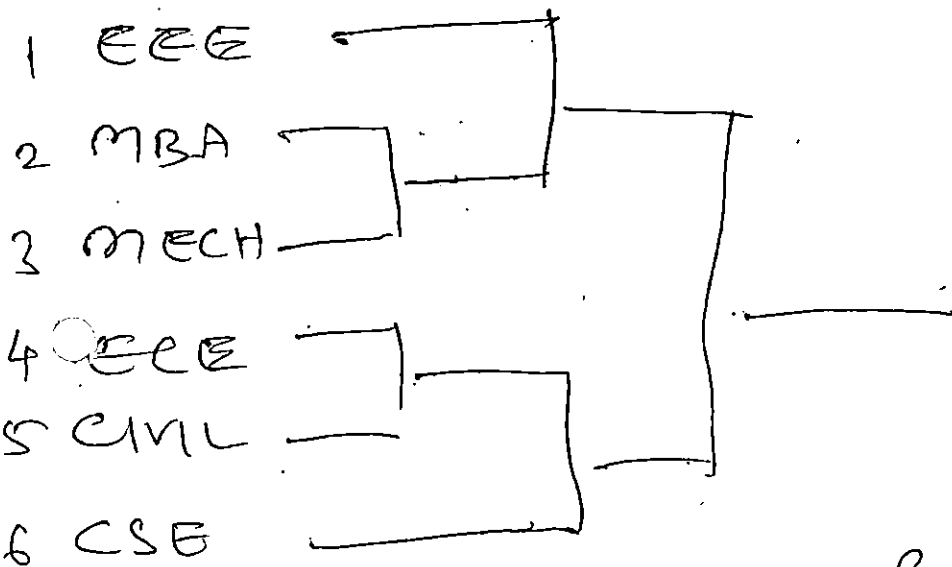

- 1. T. Satya Sairesh (MECH) - IV
- 2. C. Namsikrishna (ECE) - IV
- 3. ANURAG GAUTAM (ECE) - IV
- 4. S. Sai Charan (CSE) - III
- 5. T. Sai Kishore (CIVIL) - I

[Signature]
Vamsi

[Signature]
Dai Charan
Kishore

[Signature]

ANNUAL DAY SPORTS FIXTURES 2018

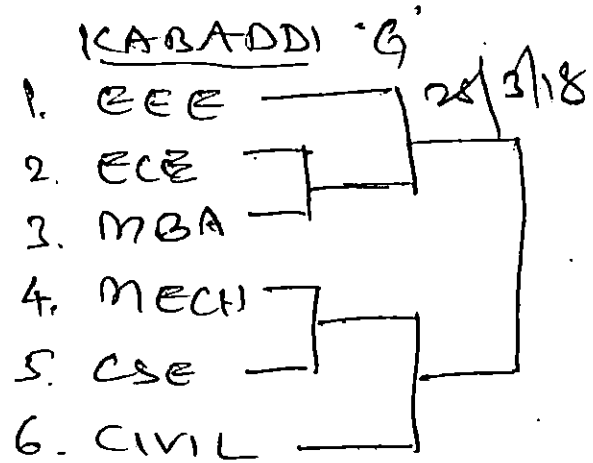
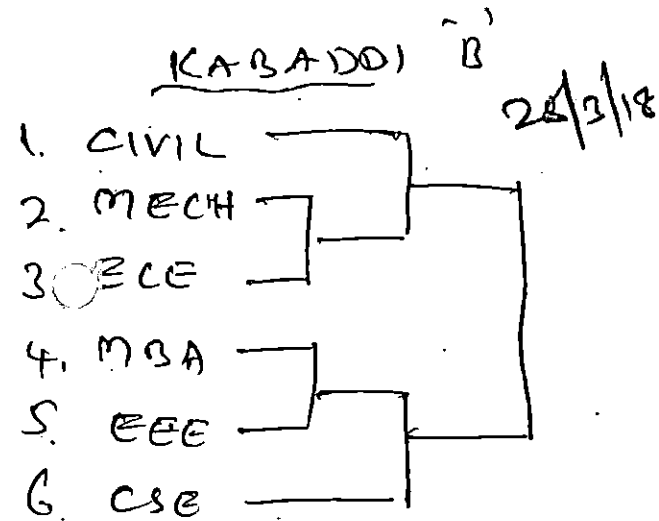
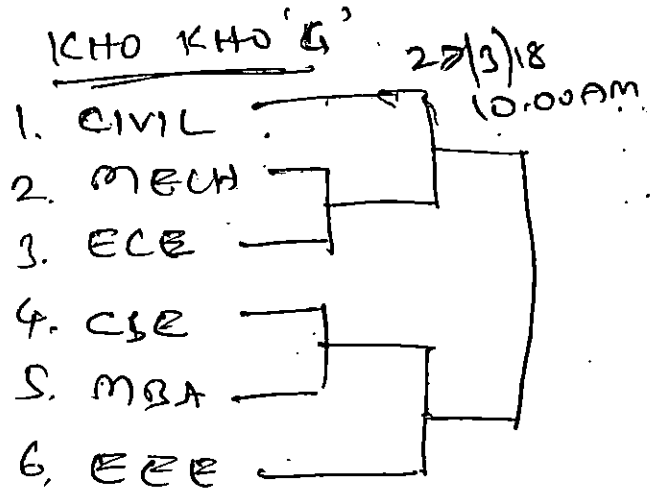
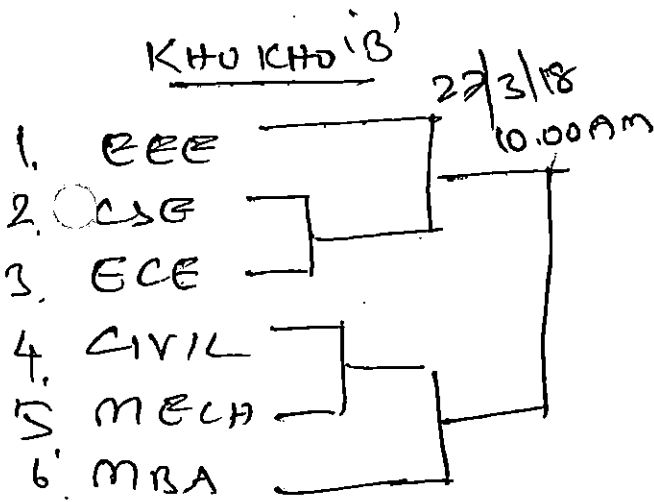
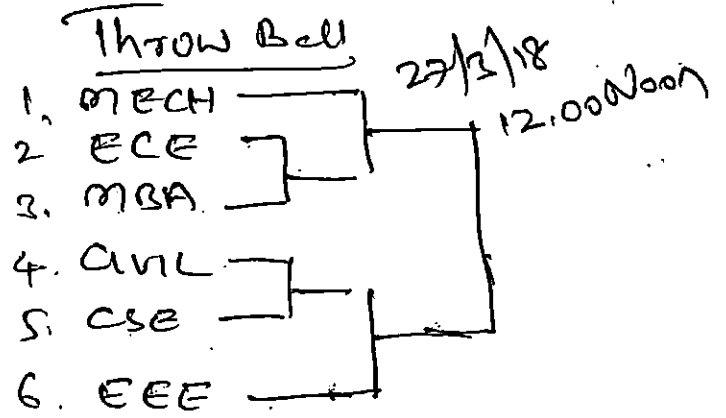

1. Tenorsoft will be on 29th March 2018 11.30 AM
2. Table Tennis on 28th March 2018 11.00 AM.
3. Chess & Carrom on 28th March 2018 10.00 AM

~~28/3~~

P. Anvesh Reddy 2. Namsikrishna 3.
 4. 5. Satya - Sathya & S. Sanjay

Event Photos: Annual Sports day Tournaments

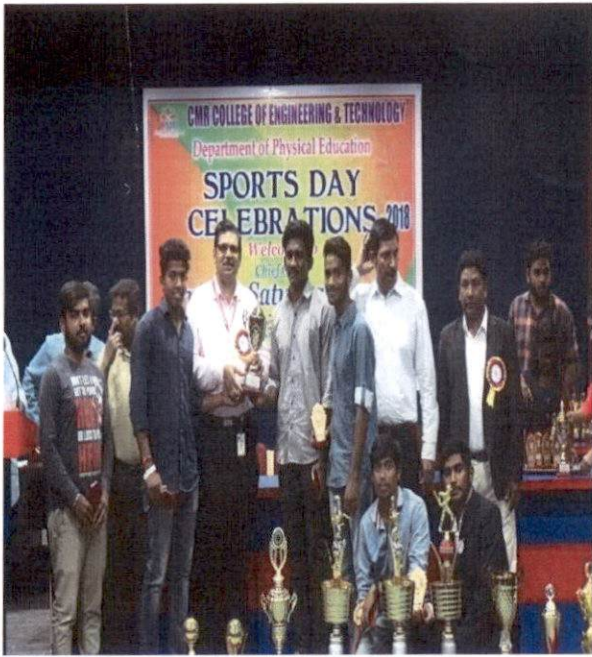

PRINCIPAL
CMR COLLEGE OF ENGG. & TECH.
Kandlakoya (V), Medchal Road,
Hyderabad-501401.



CMR College of Engineering & Technology (AUTONOMOUS)

* Approved by AICTE * Permanenently affiliated by JNTUH *
* Accredited by NAAC with 'A' Grade * All B.Tech programs Accredited by NBA *

REQUIRMENT OF PRIZES FOR ANNUAL DAY SPORTS -- 2018. ESTIMATED EXPENDITURE FOR PRIZES (APPROX)

SL.NO	EVENT	WINNER CUP	RUNNER CUP	INDIVIDUAL		3 RD PLACE
				WINNER	RUNNER	
01	CRICKET	600.00	500.00	120X110=13200.00	120X90=10800	-
02	BASKET BALL	600.00	500.00			
03	VOLLEY BALL	600.00	500.00			
04	THROW BALL (W)	600.00	500.00			
05	FOOT BALL	600.00	500.00			
06	KHO-KHO (M/W)	1200.00	1000.00			
07	CRICKET STAFF(M/W)	1400.00	1200.00			
08	THROW BALL STAFF	600.00	500.00			
09	KABADDI (M/W)	1200.00	1000.00			
10	TENNICOIT/CHESS	-	-	5X300=1500.00	5X250=1250.00	
11	T.T. & CARRAM (M/W)	-	-	12X300=3600.00	12X250=3000.00	
12	BEST PLAYER OF THE YEAR SPECIAL MOVEMENTOS	1300.00 2000.00	-	-	-	
13	UNIVERSITY/NATOINAL PLAYERS TRACK/MOMENTO			19X300=5700.00 7X300=2100.00		19X900=17100.00 7X900= 6300.00
14	CRICKET/KHO KHO (Girls/Boys) FOOTBALL MOMENTO'S & TRACKS			40X300=12000.00 18X300=5400.00		40X900=36000.00 18X900=16200.00
15	PRESIDENT/ANCHERS			3X500=1500.00		
16	Momento's HOD's			20x300=6000.00		
17	KABADDI PLAYERS TRACK/MOMENTO			13X400.00=5200.00		13X1350=17550.00
18	STAFF CRICKET TEAMS	15 PLAYERS	6 TEAMS			90X300=27000.00
19	STAFF CRICKET TEAMS (w)	11 PLAYERS	4 TEAMS			44X300=13200.00
		10,700.00	6,200.00	66,200.00	15,050.00	1,33,350.00

TOTAL ESTIMATION (In Rupees)

2, 31,500.00

*Rs 2,00,000/- sanctioned.
Please purchase the cups*

*Accounts
for na
27/3/18*

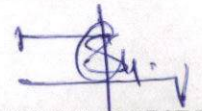
 PHYSICAL DIRECTOR

CMR COLLEGE OF ENGINEERING & TECHNOLOGY

AN UGC AUTONOMOUS INSTITUTION
(Approved by AICTE, Permanently Affiliated to JNTU Hyderabad)
(NAAC Accredited Institutions with 'A' Grade)

Kandlakoya, Medchal Road, Hyderabad - 501 401. Phone : (08418) 200699, 9248727210, www.cmrct.org

PAYMENT LETTER

Date 2-3-18

From
Name Syed Rafeeq
Designation PD
In-charge
Dept. Physical Director

To
The Principal

Sir,
Sub: Payment to M/s ESS HANDICRAFTS Request Reg.

Ref: I. Our order No. 2 Dated 27-3-18
II. Invoice No Dated

We have placed Order an amount of Rs. 98,150 (in words Ninety eight thousand One hundred fifty) equipment for the library

Department on M/s. Ess Handicrafts With purchase order no. cited in Ref. I

We have received the equipment from the above mentioned firm with good condition and working satisfactory. Hence I request you to pay the following amount to the above mentioned firm.

A) Total Ordered Amount	Date <u>27-3-18</u> Rs. <u>98,150-00</u>
B) Advance Paid along with Purchase Order	Date Rs.
C) Amount paid / to be paid against invoice No.....	Date <u>2-4-18</u> Rs. <u>90,065-00</u>
D) Amount paid / to be paid against invoice No.....	Date Rs.
E) Amount paid/to be paid against invoice No.....	Date Rs. <u>/</u>
F) Amount paid /to be paid against invoice No.....	Date Rs.

Total Rs. 90,065-00

(Amount to paid (A-B-C-D-E-F)
(in words Ninety thousand and Sixty five only)

Thanking you
Yours faithfully,
In-charge
V. Srinivas
19/6/18

Recommended & Forwarded
Head of the Department
PRINCIPAL
CMR COLLEGE OF ENGG. & TECH.
Kandlakoya (V), Medchal Road,
Hyderabad-501401.

X INVOICE

GSTIN NO.: 36AABFE8927D1Z1

L No. **2414**

Date: **21/4/2018**

CASH / CREDIT CARDS / BANK



ESS HANDICRAFTS

(SSI UNIT No. 280061102310 A Govt. Of India Recognized Craftmen's Small Scale Unit)
 Shop No. 9 & 10, Cellar, Hardy Complex, M.G. Road, Secunderabad - 500 003. TELANGANA.
 Ph : 040-27819834/33, 040-27755405
 E-mail : esshandicrafts27819834@gmail.com , esshandicrafts_hyd@yahoo.co.in
 Works : Hasmatpet, Secunderabad.

To: The principal,
 CMR college of Engineering &
 Technology.

Buyer's GSTIN No: _____

Buyer's Telephone No. _____

D.C. No. _____

No. Of Pkgs. _____

Sl. No.	PARTICULARS / DESCRIPTION	HNS Code	Qty.	Rate	Amount
1	S'memento's Winner Cup	8306	12p	600/-	7200 ~
2	" Runner Cup	"	12p	500/-	6000 ~
3	" Individual Small winner	"	120p	110/-	13200 ~
4	" " Runner	"	120p	90/-	10800 ~
5	" Individual games winner	"	17p	300/-	5100 ~
6	" " Runner	"	17p	250/-	4250 ~
7	" Boig / Trophy	"	2p	1450/-	2900 ~
8	" Memento's	"	84p	300/-	25200 ~
9	" Round memento's	"	5p	500/-	2500 ~
10	" wooden Round	"	20p	300/-	6000 ~
11	" Individual memento's	"	13p	400/-	5200 ~
12	" Guest memento's	"	1p	1000/-	1000 ~
		Sub Total		dece	89350 ~
	TAX @ CMR GROUP OF INSTITUTIONS KANDLAKOYA, MEDCHAL	Central Tax (GST)			
	Date: 21/4/18 Time: 10:30	State Tax (SGST)			
		TOTAL			89350 ~ P.T.O

E. & O.E.

S.No: **471**
 Rupees in words: **Four hundred and seventy one only**

Bank Details : **ANDHRA BANK**, M.G. Road, Secunderabad.
 A/c No. **036213046002460** • IFSC Code : **ANDB0000362**

For **ESS HANDICRAFTS**

Bhena
 Authorised Signatory

PRINCIPAL
 CMR COLLEGE OF ENGG. & TECH.
 Kandlakoya (V), Medchal Road,
 Hyderabad-501401.

L No. 2415

Date : 24/2018

CASH / CREDIT CARDS / BANK



ESS HANDICRAFTS

(SSI UNIT No. 280061102310 A Govt. Of India Recognized Craftmen's Small Scale Unit)
 Shop No. 9 & 10, Cellar, Hardy Complex, M.G. Road, Secunderabad - 500 003. TELANGANA.
 Ph : 040-27819834/33, 040-27755405
 E-mail : esshandicrafts27819834@gmail.com , esshandicrafts_hyd@yahoo.co.in
 Works : Hasmatpet, Secunderabad.

To,
 the principal,
 CMR college of Engineering &
 Technology

Buyer's GSTIN No: _____

Buyer's Telephone No. _____

D.C. No. _____

No. Of Pkgs. _____

Sl. No.	PARTICULARS / DESCRIPTION	HNS Code	Qty.	Rate	Amount
				B/F	89350.00
				less	8935.00
<p style="text-align: center;">CMR GROUP OF INSTITUTIONS KANDLAKOYA, MEDCHAL Date: 23/04/18 Time: 10:30 S.No: 471</p> <p style="text-align: center;"><i>[Signature]</i></p>					
Sub Total					80415.00
TAX @ 12%				6%	4825.00
				6%	4825.00
TOTAL					90065.00

E. & O.E.

Rupees in words: Ninety thousand Sixty five Rupees only

Bank Details : ANDHRA BANK, M.G. Road, Secunderabad.
 A/c No. 036213046002460 • IFSC Code : ANDB0000362

For **ESS HANDICRAFTS**

[Signature]
 Authorised Signatory

ST																			
----	--	--	--	--	--	--	--	--	--	--	--	--	--	--	--	--	--	--	--

PRINCIPAL
 CMR COLLEGE OF ENGG & TECH.
 Kandlakoya (V), Medchal Road,
 Hyderabad-501401.



A/c Pay Only

Preferred

PLOT NO.1 TO 7 G.K.PROPERTIES,
RANGAREDDY,MEDCHAL, HYDERABAD-501401, TELANGANA
RTGS / NEFT IFSC : HDFC0001640

Weekly Holiday on SUNDAY

10-04-2018

D D M M Y Y Y Y
Valid for 3 months only

ESS HANDICRAFTS

Or Bearer

Pay

या धारक को
XXXXXXX

** Ninety Thousand Sixty Five Rupees Only**

Rupees रुपये

अदा करें

₹ ** 90,065 /--

A/c. No.
खाता क्र.

16408640000031

Brn: 1640 Pdt:864
APEX CA

For CMR COLLEGE OF ENGINEERING AND TECHNOLOG

Payable at par through clearing/transfer at all branches of HDFC BANK LTD

[Signature]

Authorised Signatories

Please sign above / कृपया यहाँ हस्ताक्षर करें

⑈ 102145⑈ 500240039⑈ 001765⑈ 29

PRINCIPAL
CMR COLLEGE OF ENGG. & TECH.
Kandlakoya (V), Medchal Road,
Hyderabad-501401.

CMR COLLEGE OF ENGINEERING & TECHNOLOGY

AN UGC AUTONOMOUS INSTITUTION
(Approved by AICTE, Permanently Affiliated to JNTU Hyderabad)
(NAAC Accrediated Institutions with 'A' Grade)

Kandlakoya, Medchal Road, Hyderabad - 501 401. Phone : (08418) 200699, 9248727210, www.cmrctet.org

PAYMENT LETTER

12-18

Date 23.18

From

Name Syed Rafiq
Designation P.D.
In-charge
Dept. physical education

To
The Principal

Sir,

Sub: Payment to M/s KARISHMA SPORTS Request Reg.

Ref: I. Our order No. 1 Dated 27.3.18
II. Invoice No. 436 Dated 30.3.18

We have placed Order an amount of Rs. 1,33,300-00 (in words One lakh thirty three thousand three hundred and fifty only) equipment for the library

Department on M/s Karishma Sports With purchase order

no. cited in Ref. I

We have received the equipment from the above mentioned firm with good condition and working satisfactory. Hence I request you to pay the following amount to the above mentioned firm.

A) Total Ordered Amount	Date <u>27.3.18</u>	Rs. <u>1,33,300-00</u>
B) Advance Paid along with Purchase Order	Date	Rs.
C) Amount paid / to be paid against invoice No. <u>436</u>	Date <u>30.3.18</u>	Rs. <u>1,36,500-00</u>
D) Amount paid / to be paid against invoice No.	Date	Rs.
E) Amount paid/to be paid against invoice No.	Date	Rs.
F) Amount paid /to be paid against invoice No.	Date	Rs.

Total Rs. 1,36,500-00

(Amount to paid (A-B-C-D-E-F)
(in words One lakh thirty six thousand and five hundred)

Thanking you
Yours faithfully,
In-charge

[Signature]

To Acts
pay ch
1.1.18

Recommended & Forwarded
Head of the Department

PRINCIPAL
CMR COLLEGE OF ENGG. & TECH.
Kandlakoya (M), Medchal Road,
Hyderabad-501401.

TAX INVOICE



Karishma Sports

Spl In: Sports Wear & Knitted Fabrics

Shop No: 11, HM Ishaq Estates, MG Road, Secunderabad - 3.

Ph: 040-64506338, +91-9849996338, +91-9246336338

karishmasports@hotmail.com

GSTIN: 36BFQPS6235H1ZW

INVOICE No: 436

Date: 30-3-18

Billed to: To, THE PRINCIPAL,
 V/s _____
 Address: CMR COLLEGE OF ENGG & TECH
 State: _____ State Code: _____
 Party GSTIN _____

Shipped to: _____
 M/s _____
 Address: _____
 State: _____ State Code: _____
 Party GSTIN _____

No.	PARTICULARS	HSN Code	GST RATE	QTY	RATE EACH		AMOUNT		
					Rs.	Ps.	Rs.	Ps.	
1)	TRAP SUIT (UPPER) DIGITAL	611	5%	13set	900		11700		
2)	TRAP LOWER	611	5%	13set	450		5850		
2)	TRAP SUIT S/P	611	5%	84set	900		75600		
3)	T-SHIRT DISTRICT CMR GROUP OF INSTITUTIONS KANDLAKOYA, MEDCHAL	611	5%	134 P	275		36850		
Date: 03/04/18 Time: 10:30 S.No: 470							Grand Total		1,30,000

Electronic Reference Number: _____ E.&O.E

Description	Taxable Value	CGST		SGST		IGST		Total Value
		Rate	Value	Rate	Value	Rate	Value	
Net Total	1,30,000/-	2-5%	3250/-	2-5%	3250/-			1,36,500/-

Net Total In Words:

Subject to Secunderabad Jurisdiction only.
 Received the above goods in order
 and good condition.

(Signature)
 PRINCIPAL
 CMR COLLEGE OF ENGG & TECH.
 Kandlakoya (V), Medchal Road
 Secunderabad-501401.

For Karishma Sports
(Signature)
 Authorised Signatory

HDFC BANK

A/c Pay Only

Preferred

PLOT NO.1 TO 7 G.K.PROPERTIES,
RANGAREDDY, MEDCHAL, HYDERABAD-501401, TELANGANA
RTGS / NEFT IFSC : HDFC0001640

KARISHMA SPORTS

Weekly Holiday on SUNDAY

10-04-2018
D D M M Y Y Y Y
Valid for 3 months only

Or Bearer

Pay

** One Lac Thirty Six Thousand Five Hundred Rupees Only**

या धारक को
XXXXXXX

Rupees रुपये

अदा करें

₹

** 136,500 /--

A/c No.
खाता क्र.

16408640000031

Brn: 1640 Pdt:864
APEX CA

Payable at par through clearing/transfer at all branches of HDFC BANK LTD

For CMR COLLEGE OF ENGINEERING AND TECHNOLOG

Authorised Signatories

Please sign above / कृपया यहाँ हस्ताक्षर करें

⑈ 102144⑈ 500240039⑈ 001765⑈ 29

PRINCIPAL
CMR COLLEGE OF ENGG. & TECH.
Kandlakoya (V), Medchal Road,
Hyderabad-501401.

Event Report: Annual Sports day Tournaments in the month of March 2018

- Request letter to principal to organize the Annual day Sports through IQAC Coordinator.
- Got the approval from Principal to organize the Annual Sports day matches during the month of March.
- Circular issued to students for the Annual Sports day matches and asked for entries.
- The Draws have been taken out in the presence of 6 committee members and the captains of various teams, and after the completion of matches results were declared.
- The matches were conducted in CMRCET Grounds
- 10 students from Sports Club & 3 students from photography club were involved in the Annual day matches & they made it grand success, and also the sports committee members of our college were present for this event.
- Prize distribution program held on 31st March, 2018 .
- The budget Sanctioned for the tournament was Rs2,31,500 and the expenditure for the tournament is Rs 2,26,565 the account has been settled immediately after the tournament.
-

Outcomes:

During these matches few students who are good at various sports & games skills got selected for further training and they can be sent for college team, other university & National level

Thanking you sir



Convener
Sports & Games Committee



CMR COLLEGE OF ENGINEERING & TECHNOLOGY

(AUTONOMOUS)

NAAC Accredited Institution with 'A' Grade

Kandlakoya (V), Medchal Road, Hyderabad -501401.

CMRCET/PRIN/ SPORTS/AY2017-18/CIR-10

Date: 13/04/2018

CIRCULAR

All the sports & Games committee members are hereby informed that, the Annual review of sports committee meeting is scheduled on 17.04.2018. The venue will be the Department of Physical Education at 3.00pm. All are requested to be present on time.

The Agenda of the meeting is:

- i) Review meeting on the events conducted in current Academic Year.
- ii) Discussion on non conduct /extra conducted events

Convener
Sports & Games Committee

Principal

Copy Submitted to: (1) The Secretary Garu – For your kind information Pl.

Copy to:

1. IQAC Coordinator
2. Controller of Examinations
3. All HODS
4. Administrative Officer
5. Accounts Officer
6. Concerned Faculty
7. Students Notice Board



CMR COLLEGE OF ENGINEERING & TECHNOLOGY

(AUTONOMOUS)

NAAC Accredited Institution with 'A' Grade

Kandlakoya (V), Medchal Road, Hyderabad -501401.

SPORTS & GAMES COMMITTEE MINUTES OF MEETING

1. The Meeting was held on 17th April 2018 from 3.00 to 4:00 pm in the Department of Physical Education.
2. The Convener welcomed all the committee members
3. The Convener started the meeting with congratulating them for the smooth conduction of current Academic year Programs in all the events took place.
4. All the events were conducted smoothly with the help of all committee members
5. Discussed about the problems faced in conduction of Games.
6. Committee members suggested the modifications.
7. The Sports Committee members planned to organize Training Sessions (Coaching) for interested students from next Academic year onwards
8. All the members accepted the suggestions.
9. The Committee members discussed about the reviews of the unplanned event "JNTUH Zone 'C' and Central Zone Football Tournament", organized by our college, allotted by JNTUH sports authority.

The List of Sports Committee members attended the meeting:

S.No	Name of the member	Designation	Position	Signature
1.	Major Dr. V. A. Narayana	Principal	Chairman	
2.	Mr. Syed Rafeeq	Physical Director	Convener	
3	Mr. B. Dharma Teja	Assistant Professor	Member	
4	Mr. Md. Sirajuddin	Assistant Professor	Member	
5	Mr. S. Anil	Assistant Professor	Member	
6	Mr. G. Saidulu	Assistant Professor	Member	
7	Mr. G. Rajanand	Assistant Professor	Member	
8	Mr. V. Hariṣh	Assistant Professor	Member	
9	Ms. N Snehitha	Assistant Professor	Member	
10	Mohd. Akheel Ahmed	Student	Member	
11	P. Vivek	Student	Member	
12	M. Ajith Kumar	Student	Member	
13	M. Srinath	Student	Member	
14	L. Harshini	Student	Member	

Convener
Sports & Games Committee

Principal



CMR COLLEGE OF ENGINEERING & TECHNOLOGY

(AUTONOMOUS)

NAAC Accredited Institution with 'A' Grade

Kandlakoya (V), Medchal Road, Hyderabad -501401.

Date: 27.04.2018

To,
IQAC Coordinator
CMRCET

Sub: Annual report for the Sports events conducted under Sports & Games committee in the
A.Y: 2017-18- Reg.

Respected Sir,

As you are aware that, the Sports & Games Committee organized different sports events for students this year, right from the beginning of the Academic year, with prior permission, herewith I am submitting the Annual report of the events conducted for the A.Y: 2017-18.

The list of events conducted in the current Academic Year 2017-18

1. Conducted Elite Football Cup in the month of July on every Saturday (8th, 15th & 22nd of July, 2017)
2. CMRCET Volley ball Super League was conducted in the month of August on every Saturday (12th, 19th & 26th of August, 2017)
3. Conducted CMR Pro Kabaddi in the month of September on first two Saturdays (9th & 16th of September 2017)
4. 4th TSIEC Football Tournament was organized from 22nd to 24th September, 2017. The expenditure is Rs 1,68,449
5. Engineer's Throw Ball & Indoor Games Tournament events were conducted in the month of October on all Saturday's (7th, 14th, & 21st, 28th of October 2017)
6. Conducted Engineering Cricket & Basket ball League in the month of December on every Saturday (9th, 16th & 23rd, 30th of December, 2017)
7. On the occasion of Hidden talent search in Freshers 2018 on 12th January 2018, Fresher's day matches were conducted from 10th to 12th of January 2018. The expenditure is Rs 53,095.
8. Ultimate Kho Kho League have been conducted in the month of February on all Saturday's (10th, 17th & 24th of February 2018)
9. On the occasion of Annual Sports day scheduled on 31st March 2018, Annual Sports day matches have been conducted from 26th March 2018 onwards The expenditure is Rs 2,26,565

Apart from the above Year plan events, an extra unplanned event conducted, assigned by JNTUH

JNTUH ZONE 'C' and Central Zone INTER ENGINEERING COLLEGIATE FOOTBALL Tournament Organized from 24th to 27th March 2018. The expenditure is Rs 1,16,206

The detailed reports for all the above events are as enclosed

Overall Program Outcomes: Through participation in Sports & Games, a student gains various skills, experience and confidence that are helpful for developing their personality ,

Resolution: Sports & Games Committee successfully organized all the events during the academic year 2017-18. All committee members have decided to endeavor with same enthusiasm for next academic year: 2018-19.

Thanking you,

A handwritten signature in blue ink, appearing to be 'S. V.', is written over a horizontal line.

Convener

Sports & Games Committee



CMR College of Engineering & Technology (AUTONOMOUS)

* Approved by AICTE * Permanently affiliated by JNTUH *

* Accredited by NAAC with 'A' Grade * All B.Tech programs Accredited by NBA *

DEPARTMENT OF PHYSICAL EDUCATION ACHEIVEMENTS OF THE YEAR 2017 - 18.

Sl. No.	Name of the Tournament	Branch/ year	H.T. No	Game	Organizing College	Dates	Remarks
1.	UDAAN Inter college Cultural Literacy & Sports	-	-	KABADDI	ACE Engg. College, Ghatkesar	28 th to 30 th Dec, 2017	WINNERS
2.	TECH TROPHY 2K18	-	-	KHO KHO (W)	MREC W	6 th to 7 th Jan 2018	RUNNERS
3.	VERVE - 2K18 State level sports fest.	-	-	KHO KHO (W)	GNITS	22 nd & 23 rd Jan 2018	RUNNERS
4.	ARENA-18 National Annual Sports Meet	-	-	KABADDI	BITS Pilani, Hyd	25 th to 28 th Jan 2018	RUNNERS
5.	10 th Indian Open Inter college sports meet 2018	-	-	KHO KHO	VNRVJET	31 st Jan & 1 st feb 2018	RUNNERS
6.	10 th Indian Open Inter college sports meet 2018 SAI AKSHAY	CSE III	15H51A05B9	CHESS	VNRVJET	31 st Jan & 1 st feb 2018	III Place
7.	JNTUH Zone C Cricket Tournament.	-	-	CRICKET	MRCET	15 th to 19 th Feb, 2018	WINNERS
8.	KREEDA 2K18 Sports meet	-	-	KABADDI	TIRUMALA Engg. College	19 th & 20 th Feb, 2018	WINNERS
9.	KREEDA 2K18 Sports meet	-	-	KHO KHO (M)	TIRUMALA Engg. College	19 th & 20 th Feb, 2018	RUNNERS
10.	KREEDA 2K18 Sports meet	-	-	KHO KHO (W)	TIRUMALA Engg. College	19 th & 20 th Feb, 2018	RUNNERS
11.	ALL MEDCHAL DIST, SPORTS & GAMES	-	-	KABADDI	Dist. Association SHAMEERPET	20 th & 21 st Feb, 2018	RUNNERS
12.	JNTUH Central Zone tourney	-	-	KABADDI	NREC	26 th & 27 th Feb, 2018	RUNNERS
13.	ATHLEMA 18	-	-	FOOT BALL	MVSR	20 th & 21 st March, 18	WINNERS

14	JNTUH CENTRAL ZONE C TOURNAMENT	-	-	FOOT BALL	CMRCET	24 th & 25 th March, 18	WINNERS
15	JNTUH CENTRAL ZONE TOURNAMENT	-	-	FOOT BALL	CMRCET	26 th & 27 th March, 18	RUNNERS

 Physical Director



CMR COLLEGE OF ENGINEERING & TECHNOLOGY

Kandiakoya (V), Medchal Road, Hyderabad-501401.

Phone No: 08418 – 329342, 224988, 260699, and 9247605108.

DEPARTMENT OF PHYSICAL EDUCATION ACHEIVEMENTS OF THE YEAR 2017 – 18..

UNIVERSITY REPRESENTED PLAYERS – 2017-18.

Sl. No.	Name of the Player	Branch/ year	H.T. No	Game	Organized University	Dates	Remarks
1.	T. RAJESH KUMAR	CIVIL II	16H51A01B2	YOGA	KIIT UNIVERSITY	1 st to 4 th Oct, 2017	
2.	G. HARIKA	CSE IV	14H51A05K4	KHO KHO	UNIVERSITY OF MYSORE	4 th to 7 th Oct, 2017.	
3.	C.S. NAVYA	CSE IV	14H51A05F2	KHO KHO	UNIVERSITY OF MYSORE	4 th to 7 th Oct, 2017.	
4.	N. SRILEKHA	ECE III	15H51A0439	KHO KHO	UNIVERSITY OF MYSORE	4 th to 7 th Oct, 2017.	
5.	SAI AKSHAY	CSE III	15H51A05B9	CHESS	ANNA UNIVERSITY	19 th to 22 nd Oct, 2017	
6.	K. SHIVA NAGARAJ	ECE II	16H51A04P2	HAND BALL	KRISHNA UNIVERSITY	21 st to 24 th Oct, 2017	
7.	ANURAG GOUTHAM	ECE IV	14H51A0401	PISTOL SHOOTING	GURUNANAK UNIVERSITY	10 th to 14 th Nov, 2017	
8.	M.R.SAI SHRAVAN KUMAR	ECE IV	14H51A0432	PISTOL SHOOTING	GURUNANAK UNIVERSITY	10 th to 14 th Nov, 2017	
9.	C. VAMSHI KRISHNA	EEE IV	14H51A0270	FOOT BALL	CALICUT UNIVERSITY	22 nd to 25 th Nov, 2018	
10.	M.R.SAI SHRAVAN KUMAR	ECE IV	14H51A0432	FOOT BALL	CALICUT UNIVERSITY	22 nd to 25 th Nov, 2018	
11.	MURALI KRISHNA	MECH II	16H51A0382	KABADDI	SATHYA BAMA UNIVERSITY	19 th to 21 st Nov, 2017	
12.	J. SRAVYA	CIVIL III	15H51A0180	GYMNASTICS	KURUKSHETRA UNIVERSIT	14 th to 19 th Jan 2018	
13.	B. ANIL	MECH II	16H51A02	KHO KHO	UNIVERSITY OF MYSORE	20 th to 26 th Jan 2018	
14.	E. ADITYA	CSE III	15H51A0503	HOCKEY	BANGALORE UNIVERSITY	22 nd to 27 th Jan 2018	
15.	CH. AKHIL CHAKRAVARTHI	CSE II	16H51A0575	HOCKEY	BANGALORE UNIVERSITY	22 nd to 27 th Jan 2018	
16.	G. MANASA	CIVIL II	16H51A0179	BALL BADMINTON	DRAVIDIAN UNIVERSITY	5 th to 9 th Feb 2018	

17.	K. MONICA	ECE I	17H51A04L6	BALL BADMINTON	DRAVIDIAN UNIVERSITY	5 th to 9 th Feb 2018	
18	M. INDRAJA	ECE III	15H51A0584	SOFT BALL	PURUNANAK UNIVERSITY	3 rd to 7 th March 2018	
19	J. POOJA	CSE I	17H51A05G5	NET BALL	MANGALORE UNIVERSITY	19 th to 22 nd Feb, 2018	



CMR COLLEGE OF ENGINEERING & TECHNOLOGY

Kandlakoya (V), Medchal Road, Hyderabad-501401.

Phone No: 08418 – 329342, 224988, 260699, and 9247605108.

DEPARTMENT OF PHYSICAL EDUCATION

NATIONAL REPRESENTED PLAYERS – 2017-18.

Sl. No.	Name of the Player	Branch/ year	H.T. No	Game	Organizing State	Dates	Remarks
1.	G. MANASA	CIVIL II	16H51A0179	BALL BADMINTON	KARNATAKA	4 th to 8 th Oct 2017	
2.	K. MONICA	ECE I	17H51A04L6	BALL BADMINTON	KARNATAKA	4 th to 8 th Oct 2017	
3.	MANOJ	CSE I	17H51A05N1	KICK BOXING	DELHI	II nd week of Nov, 2017	
4.	ANURAG	ECE IV	14H51A0401	PISTOL SHOOTING	KERALA	15 th to 17 th Nov, 2017	
5.							
6.	J. SRAVYA	CIVIL III	15H51A0180	GYMNASTICS	PUNJAB	15 th to 19 th Feb, 2018	
7.	P. AKSHAY	MECH II	16H51A0391	WRESTLING	RAJASTAN	22 nd to 25 th Feb, 2018	



PRINCIPAL
CMR COLLEGE OF ENGG. & TECH.
Kandlakoya (V), Medchal Road,
Hyderabad-501401.



PRINCIPAL
CMR COLLEGE OF ENGG. & TECH.
Kandlakoya (V), Medchal Road,
Hyderabad-501401.

3



CMR COLLEGE OF ENGINEERING & TECHNOLOGY
KARUNAGAPURAM
PHONE: 0435-250141

Pragati

15th INDIAN OPEN IN ENGG

TECHNICAL COLLEGE

DA
NEW YORK



PRINCIPAL
CMR COLLEGE OF ENGG. & TECH
Kandlakoya (M), Medchal Road,
Hyderabad-501401.



PRINCIPAL
CMR COLLEGE OF ENGG. & TECH.
Kandlakoya (V), Medchal Road,
Dist. 501401

6



ENGINEERING AND



10th INDIAN OPEN INTER
ENGINEERING COLLEGIAT

SPORTS



PRAGATI
ENGG & TECH
Medchal Road
Karimnagar
-501401





BLOCK-I

C.M.R. COLLEGE OF ENGINEERING & TECHNOLOGY

PRINCIPAL
C.M.R. COLLEGE OF ENGINEERING & TECHNOLOGY
Kandlakota (V), Medchal
Hyderabad-501401

C.M.R. COLLEGE OF ENGINEERING & TECHNOLOGY
Kandlakota (V), Medchal
Hyderabad-501401

12

AMERICAN

16



CMR
Ka

3



MVS ENGINEERING COLLEGE

(APPROVED & AFFILIATED)
AFRICA UNIVERSITY
NIA UNIVERSITY
LIFE UNIVERSITY
TRABAD
Nati
Int
Engineering Co
Sport
OR
ED BY
ENT

PRINCIPAL
CMR COLLEGE OF ENGINEERING & TECHNOLOGY
Kandlakoya (V), Medchal Road,
Hyderabad-501401.



BLOCK-I

C.M.R. COLLEGE OF ENGINEERING & TECHNOLOGY

C.M.R. COLLEGE OF ENGINEERING & TECHNOLOGY
Hyderabad

C.M.R. COLLEGE OF ENGINEERING & TECHNOLOGY
Hyderabad

PRINCIPAL
C.M.R. COLLEGE OF ENGINEERING & TECHNOLOGY
Medchal Road,
Hyderabad-501401



PRINCIPAL
CMR COLLEGE OF ENGG & TECH.
Kandlakoya (V), Medchal Road,
Hyderabad-501401.

ప్రజల చెంతకు పరిపాలన

మేడ్చల్

ntnews.com | ntmedchal.com

విద్యార్థులకు పరిక్ష సామగ్రి పంపిణీ



కొత్త పంచాయతీ కరిగూడ గ్రామ మ్యాప్

కీసర: పరైలే దేశానికి పట్టుకోవ్వలసినది మహాత్మాగాంధీ సిద్ధాంతం. దిన్న పంచాయతీలు ఏర్పడినప్పుడు అభివృద్ధి ప్రజలకు చేరువవుతుందని సీఎం కేసీఆర్ సిద్ధాంతం. నూతన జిల్లాలు ఏర్పడిన విధంగానే పంచాయతీలను ఏర్పాటు చేస్తేనే ప్రజలకు పాలన మరింత చేరువవుతుందని సీఎం జాబించారు. ఆ దశగా కొత్త పంచాయతీల ఏర్పాటుకు ప్రభుత్వం శ్రీచారం చుట్టింది. నగర శివారు గ్రామాల్లో పెరుగుతున్న జనాభాను దృష్టిలో పెట్టుకొని తెలంగాణ ప్రభుత్వం తీసుకున్న శాశా నిర్ణయంతో గ్రామాలు మరింతగా పురోభివృద్ధి పడంలో పడుతోన్నాయి. నగర పంచాయతీలు ఏర్పాటు అవుతుండటంతో రాష్ట్ర, కేంద్ర

సీఎం కేసీఆర్ కు కృతజ్ఞతలు
 నూతన పంచాయతీలు ఏర్పడటం వల్ల పరిపాలన సలువవుతుంది. ప్రజల సమస్యలు వెంటనే పరిష్కరించవచ్చు. ఉద్యమ సమయంలో సీఎం జర్జిన హామీ అమలు చేస్తూ నూతన పంచాయతీల పట్టణ తీసుకొచ్చారు. ఇక కొత్త పంచాయతీలతో గ్రామాలు నూతన ఉత్తేజంతో అభివృద్ధి చెందుతాయి. అన్ని వర్గాల ప్రజలకు ఈ పంచాయతీల ద్వారా పాలన దగ్గరవుతుంది. -మంచాల పాపయ్య కరిగూడ

నగర పంచాయతీలతో మరింత అభివృద్ధి
 నగర పంచాయతీలతో పరిపాలన చాలా సులువవుతుంది. గ్రామాల్లో ఉన్న అంతర్గత రోడ్లు, మురుగు కాలువల ఏర్పాటు, విద్యుత్ దీపాలు, శుశాసనానికి అభివృద్ధి చెక్కడంపంపియార్చుల ఏర్పాటు, శ్రీధా మైదానాల వంటి అభివృద్ధి పనులు జరుగుతాయి. -నాను నాయక్ అహ్మద్ నగర్.

ప్రభుత్వ నిధులతో పెండింగ్ అభివృద్ధి పనులను త్వరగా చేపట్టడానికి ఎంతో అవకాశం ఉంటుంది. కీసర మండలంలో మొత్తం 12 పంచాయతీలకు గాను నాగారం, రాంపల్లి గ్రామాలు కలిపి ఒక నగర పంచాయతీగా, దమ్మాయిగూడ, అహ్మద్ నగర్, రాజ్ వేగ్లహా కల్లు, గోరుమకుంట్ల పంచాయతీకి అనుబంధ గ్రామంగా ఉన్న కుందనపల్లి గ్రామానికి కలిపి దమ్మాయిగూడ పంచాయతీగా ఏర్పాటు చేశారు. మండలంలో రెండు నగర పంచాయతీలతో పాటు మరో రెండు కొత్త పంచాయతీలను ఏర్పాటు చేశారు. రాంపల్లి పంచాయతీకి అనుబంధ గ్రామంగా ఉన్న కరిగూడ గ్రామాన్ని కొత్త పంచాయతీగా ఏర్పాటు చేశారు. ఈ పంచాయతీ కింద మొత్తం జనాభా 465, సర్వేసంఖ్యలు 105, విస్తీర్ణం 862.24 ఎకరాలు, నన్నంపల్లి పంచాయతీ గ్రామం జనాభా మొత్తం 425, సర్వేసంఖ్యలు 468, 510.94 ఎకరాలను కలిపి ఉంది.



అన్నోజిగూడలో విద్యార్థులకు డిఆర్ఎస్ నాయకుడు సింగిరిన్ పాపయ్యగారికి.

మట్టికేసర: పరీక్షల్లో మంచి మార్కులు సాధించి ఇటు పాఠశాలకు, అటు తల్లిదండ్రులకు మంచి పేరు తెచ్చాలని డిఆర్ఎస్ నాయకుడు సింగిరిన్ రెడ్డి హరివర్ధన్ రెడ్డి అన్నారు. మండలంలోని మట్టికేసర, అన్నోజిగూడ ప్రభుత్వ పాఠశాల విద్యార్థులకు శనివారం పరీక్ష సామగ్రిని పంపిణీ చేశారు. కార్యక్రమంలో పంచాయతీ సర్పంచు శ్రీనివాస్ గౌడ్, నాయకులు శంకర్ రెడ్డి, శ్రీకాంత్ రెడ్డి, డిఎన్ఎస్ నాయక్, శ్రీకృష్ణ, పాఠశాల ప్రధానోపాధ్యాయులు పి.జానయ్య, డి. మాధవ్ పాల్గొన్నారు.

సీఎంఆర్ లో క్రీడోత్సవాలు



విద్యార్థులకు బహుమతులను ప్రధానం చేస్తున్న గోపాలిరెడ్డి

మేడ్చల్ రూరల్: మండల పరిధిలోని సీఎంఆర్ ఇంజనీరింగ్ కళాశాల వార్షికోత్సవంలో భాగంగా శనివారం క్రీడోత్సవాలు నిర్వహించారు. ఈ సందర్భంగా వివిధ హాటీట్ గెలుపొందిన విద్యార్థిని విద్యార్థులకు బహుమతులను ప్రధానం చేశారు. కార్యక్రమానికి ముఖ్యఅతిథిగా కాకతీయ యూనివర్సిటీ ప్రొఫెసర్ సత్యనారాయణ, సీఎంఆర్ కార్యదర్శి గోపాలిరెడ్డి, ప్రిన్సిపాల్ ఎ.పి నారాయణ, హెచ్ఎచ్ విజయకుమార్, రమీకుమార్, పీడి రఫీ చాఅయ్యారు.

ఘనంగా అలోరా ఇంజనీరింగ్ కళాశాల వార్షికోత్సవం



విద్యార్థులతో డా. ఈ.సాయిబాబారెడ్డి, కళాశాల డైరెక్టర్

మేడిపల్లి: మేడిపల్లి మండల పరిధిలోని పర్యటాఫూర్ అలోరా టెక్నాలజీ కలర్ అండ్ రీసెర్చ్ ఇనిస్టిట్యూట్లో 'అవ్వాయా' వార్షికోత్సవ వేడుకలు శనివారం ఘనంగా నిర్వహించారు. ఈ కార్యక్రమానికి ముఖ్య అతిథిగా శేషనీలయూ ఇంజనీరింగ్ కళాశాల ప్రిన్సిపాల్ డా. ఈ.సాయిబాబారెడ్డి పాల్గొన్నారు. ఈ సందర్భంగా ఆయన మాట్లాడుతూ విద్యార్థులు ఉన్నత లక్ష్యాలను సాధించాలన్నారు. అనంతరం విద్యార్థుల క్రాసికల్, వెస్ట్రన్ డ్యాన్స్ లు ప్రదర్శించారు. ప్రతిభ కనబరిచిన విద్యార్థులకు బహుమతులు అందజేశారు. కార్యక్రమంలో కళాశాల డైరెక్టర్ శ్రీకాంత్, పీఠ్య డైరెక్టర్ హరీ విశ్వంకర్, ప్రొఫెసర్స్ చరణ్ రాజు, శ్రీకాంత్ సిద్దికర్, కళాశాల అధ్యాపకులు, విద్యార్థిని విద్యార్థులు పాల్గొన్నారు.

8న భోగారంలో

డాక్టర్ బి.ఆర్. అంబేద్కర్ విగ్రహ ప్రతిష్ఠాపన

కీసర: కీసర మండలం టోగారం గ్రామంలో ఏప్రిల్ 8వ తేదీన భారత రాజ్యాంగం రచయిత డాక్టర్ బి.ఆర్. అంబేద్కర్ విగ్రహ ప్రతిష్ఠాపన కార్యక్రమం జరిగింది. గ్రామ సర్పంచ్ కుల మానస తెలిపారు. శనివారం టోగారం చక్కల అభివృద్ధి సాధించామని, అంబేద్కర్ సంఘం సేతు మేడ్చల్ ఎమ్మెల్యే సుధీర్ మంజుల పంచాయతీ కార్యదర్శి సర్వేపల్లిపూర్, పంచాయతీ సర్పంచ్ పాల్గొన్నారు.

'హితమేలో' సాంకేతిక ప్రదర్శనలు



విద్యార్థులు ఇచ్చిన సాంకేతిక ప్రదర్శనలను పరిశీలిస్తున్న అధ్యాపకులు

మేడ్చల్ రూరల్: సాంకేతిక ప్రదర్శనలు సృజనాత్మకత అని మృదలకు డోహదం చేస్తాయని ఉస్మానియా విశ్వవిద్యాలయ అధ్యాపకులు సుధీర్ ప్రేమకుమార్, వోటిపే రమణయ్య, రాజేంద్రనాయక్ పేర్కొన్నారు. మండల పరిధిలోని గౌడవెల్లి గ్రామం జ్ఞానాఫూర్లో ఉన్న హితమే ఇంజనీరింగ్ కళాశాలలో శనివారం 'ఎటికీ-2కీ18 ప్రాజెక్టు ఎక్స్ పో' పేరుతో సాంకేతిక ప్రదర్శనలు నిర్వహించారు. ఈ కార్యక్రమంలో మూసికీ ముఖ్య అతిథులుగా చూడైన సందర్భంగా వారు మాట్లాడుతూ విస్తృతంగా ఆలోచిస్తూ ప్రయోగాత్మక అభ్యయనంపై దృష్టి పెట్టాలన్నారు. చైర్మన్ ప్రకాశ్ అరుణ్, ప్రిన్సిపాల్ ఎన్.పి.ఎస్. రామకృష్ణారాజు, డి.ఎ.డి.ఎల్ మాట్లాడుతూ ప్రతి ఏటా సాంకేతిక ప్రదర్శనలు పెద్ద ఎత్తున నిర్వహిస్తూ విద్యార్థుల్లో విశ్వాసాన్ని పెంచుతున్నామన్నారు. ఈ కార్యక్రమంలో 100కు పైగా పర్యటించే మోడర్న్ ను విద్యార్థులు ప్రదర్శించారు. ఇందులో రెండు గ్రూపులుగా విభజించారు. ఫైనల్ లు, ఎటికీ టీం ప్రదర్శనలను వేర్వేరుగా ప్రదర్శించారు. ఎటికీ గ్రూప్ ప్రదర్శనలు ప్రత్యేక ఆకర్షణగా నిలిచాయి. ప్రథమ సందర్భంలో నుంచి చివరి సంవత్సరం వరకు అన్ని శాఖల విద్యార్థులు ఉండి ఈ గ్రూప్ లో నిత్యజీవితానికి ఉపయోపజీ ప్రదర్శనలను ప్రదర్శించారు. టీహెచ్.ఎల్. పైజెన్ ఫైటర్ లిమిటెడ్ సీనియర్ ప్రొడక్ట్ అసెంబ్లీ సామకుమార్, సీప్లమ్ డిజిన్ సెక్టర్ చేపట్టిన సచిన్ చోలాని న్యాయనిర్ణేతలుగా వ్యవహరించారు. వివిధ కంపెనీల అధికారులు, అధ్యాపకులు ఉత్సాహ ప్రదర్శనలను ఎంపిక చేశారు. ముగింపు కార్యక్రమంలో వారికి బహుమతులను అందజేయనున్నారు. కార్యక్రమంలో డైరెక్టర్ ఆర్.ఆర్.ఎస్. చౌదరి, ఎక్స్ పో ఆర్గనైజర్ మోరీషకుమార్, ఎటికీ ఆర్గనైజర్ హేమమూజుని పాల్గొన్నారు.

నర్సలను పరిశీలించిన ఈడిపీఆర్ డి



టోగారం సర్పంచ్ కాలిలతో మాట్లాడుతున్న ఈడిపీఆర్ డి యుగేందర్ రెడ్డి

కీసర: మండలంలోని అన్ని గ్రామాలకు పద్దో హరితహారంలో సరిపడన మొక్కలను అందిస్తామని మండల ఈడిపీఆర్ డి ఉపాధిహామీ కుశీలు కదితరులు పాల్గొన్నారు.

యుగేందర్ రెడ్డి పేర్కొన్నారు. మండల పరిధి టోగారం గ్రామంలో సర్పంచ్ పెంచుతున్న మొక్కలను శనివారం ఈడిపీఆర్ డి పరిశీలించారు. ఈ సందర్భంగా మండల ఈడిపీఆర్ డి యుగేందర్ రెడ్డి మాట్లాడుతూ మండలంలోని 12 పంచాయతీలకు సంబంధించి మండలంలోని టోగారం, గోరుమకుంట్ల గ్రామాల్లోని సర్పంచ్ మొక్కలను పెంచుతున్నామన్నారు. టోగారం సర్పంచ్ సుమారు 2 లక్షల డికు మొక్కలతో పాటు వేరే మొక్కలను పెంచుతున్నామన్నారు. కార్యక్రమంలో టోగారం పంచాయతీ కార్యదర్శి గోపాలిరెడ్డి పాటు ఉపాధిహామీ కుశీలు కదితరులు పాల్గొన్నారు.

CMR GROUP OF ENGG & TECH. KANDLA ROAD, MEDICAL ROAD, HYDERABAD-500040

17-18

సీఎంఆర్లో ఫుట్ బాల్ టోర్నమెంట్



టోర్నమెంట్ను ప్రారంభిస్తున్న సీఎంఆర్ కార్యదర్శి గోపాల్ రెడ్డి

మేడ్చల్ రూరల్ : గుండలపోచంపల్లి మున్సిపాలిటీ కండ్లకోయలో ఉన్న సీఎంఆర్ ఇంజనీరింగ్ కళాశాలలో శుక్రవారం అంతర్ ఇంజనీరింగ్ కళాశాలల ఫుట్ బాల్ టోర్నమెంట్ ప్రారంభమైంది. ఈ టోర్నమెంట్ను ప్రారంభించిన సందర్భంగా సీఎంఆర్ కార్యదర్శి గోపాల్ రెడ్డి మాట్లాడుతూ.. శారీరక, మానసిక ఎదుగుదలకు క్రీడలు దోహదం చేస్తాయన్నారు. చదువులో ఉండే ఒత్తిడి నుంచి కూడా క్రీడల ద్వారా ఉపశమనం పొందవచ్చన్నారు. ఆటల్లో గెలు పోటములు సహజమని, క్రీడాస్ఫూర్తిని ప్రదర్శించాలన్నారు. మూడు రోజుల పాటు జరిగే టోర్నమెంట్లో 38 జట్లు పాల్గొంటున్నాయి. కార్యక్రమంలో సీఎంఆర్ సెట్, ఈసీ ప్రిన్సిపాల్స్ డాక్టర్ వీపీ నారాయణ, శ్రీనివాస్ రెడ్డి, ఫార్మసీ ప్రిన్సిపాల్ అబ్బులు, పీడీ రఫీ పాల్గొన్నారు.

PRINCIPAL
CMR COLLEGE OF ENGG. & TECH.
Kandlakoya (V), Medchal Road,
Hyderabad-501401.

ఇంటింటికీ ఆరు మొక్కలు

- ◆ మూడుచింతలపల్లి, కేశవరం, లక్ష్మపూర్ గ్రామాల్లో..
- ◆ 9వేల మొక్కలను నాటేందుకు ఏర్పాట్లు
- ◆ అదర్శంగా తీర్చిదిద్దడమే లక్ష్యంగా ముందుకు



మేధుల్ జిల్లా, నమస్తే తెలంగాణ ప్రతినిధి : ముఖ్యమంత్రి కల్వకుంట్ల చంద్రశేఖర రావు ఇచ్చిన పిలుపునకు అకర్షకులైన ఆ మూడు గ్రామాల ప్రజలు గ్రామంలోని ప్రతి ఇంటిని నంద నవనంగా మార్చుకునేందుకు నిర్ణయపడ్డారు. కొద్ది రోజుల కిందట శామీర్ వేల్ మండల పరిధిలోని ముడుచింతలపల్లి, లక్ష్మపూర్, కేశవరం గ్రామాల్లో నిర్వహించిన గ్రామ సభల్లో గ్రామీణులు ముఖ్యమంత్రి పాటు నాటిిన ప్రతి మొక్కను సంరక్షించిన ప్రతి ఇంటికీ పాడి పచ్చవులను ఇస్తానని ప్రకటించిన సంగతి విదితమే. సీఎం పిలుపునకు స్పందించిన కొందరు గ్రామస్థులు మొక్కలను నాటగా, గ్రామంలో ప్రతి కుటుంబం

మొక్కలను నాటేందుకు సన్నద్ధం అవుతున్నారు. ఈ క్రమంలోనే మూడు గ్రామల్లో కలిపి సుమారు 9 వేల మొక్కలను నాటేందుకు ఏర్పాట్లు చేసుకుంటున్నారు. ఇందులో భాగంగా గ్రామాల్లో మొక్కలను నాటేందుకు అనువైన స్థలాలును సమకూర్చుకోవడంతో పాటు ప్రతి ఇంటి వద్ద ఆరు గుంతలకు తీసుకుంటున్నారు. వీరికి అవసరమైన పూలు, పండ్ల మొక్కలను సమకూర్చేందుకు చర్యలు తీసుకుంటున్నామని, ఇప్పటికే కడియం ప్రాంతం నుంచి మామిడి, సపోట వంటి పండ్ల మొక్కలతో పాటు పూల మొక్కలను తీసుకువచ్చిన జిల్లా ఫార్మర్స్ అధికారులు, జిల్లా పంచాయతీ రాజ్ శాఖ అధికారులు తెలిపారు. ఈ నెల 28 నుంచి మూడు గ్రామాల్లోను మొక్క



మొక్కలు నాటేందుకు గ్రామాల్లో సిద్ధంగా ఉన్న గుంతలు

లను నాటేందుకు చర్యలు తీసుకుంటున్నామని, అలాగే గ్రామంలోని ప్రధాన కూడళ్ల వద్ద, రహదారుల వెంట మొక్కలను నాటేందుకు ఏర్పాట్లు చేస్తున్నామని అధికారులు తెలిపారు. ఇందులో భాగంగా ఉపాధిహామీ పద్ధతంతో భాగంగా గుంతలు తీస్తున్నట్లు గ్రామీణాభివృద్ధి శాఖ అధికారులు తెలిపారు. మొక్కలను నాటే కార్యక్రమంలో గ్రామ ప్రజలతో ప్రజా ప్రతినిధులను, స్వచ్ఛంద సంస్థల ప్రతినిధులను, మహిళా సంఘాల సభ్యులను భాగస్వామ్యం చేయనున్నారు. అలాగే గ్రామాల్లో చేపట్టిన అభివృద్ధి పనులు ఖరవేగంగా జరుగుతున్నాయని, ప్రభుత్వ నిధిత గడువులోపు చేపట్టిన పనులన్నింటినీ పూర్తి చేసి అదర్శ గ్రామాలగా తీర్చిదిద్దడామని అధికారులు పేర్కొంటున్నారు.

శానిటేషన్ పర్యవేక్షణకు ప్రత్యేక బృందాలు
మేధుల్ జిల్లా, నమస్తే తెలంగాణ ప్రతినిధి : జిల్లా పరిధిలోని గ్రామాల్లో శానిటేషన్ పర్యవేక్షణకు కలెక్టర్ ఎంపీ రెడ్డి ప్రత్యేక బృందాలను ఏర్పాటు చేశారు. ఇందులో ఎంపీడీవో, ఈవోపీఆర్టీ, ఏపీవో సభ్యులుగా ఉండనున్నారు. ఇప్పటికే జిల్లాను ఓడీపీవోగా ప్రకటించిన నేపథ్యంలో జిల్లా పరిధిలోని 77 గ్రామాల్లో పారిశుధ్యం నిర్వహణతో పాటు, మాతనంగా నిర్వహించిన వ్యక్తిగత మరుగుదొడ్ల వినియోగం, దీంతో కలిగే ప్రయోజనాలపై ఈ బృందం సభ్యులు ప్రజలకు అవగాహన కల్పించనున్నారు. అలాగే ప్రత్యేక అధికారులు సైతం గ్రామాల్లో శానిటేషన్పై ప్రత్యేక నిఘా పెట్టాలని కలెక్టర్ ఇప్పటికే ఆదేశించారు. గ్రామాల్లో డంపింగ్ యార్డులను ఏర్పాటు చేసిన నేపథ్యంలో ప్రజలందరు వ్యక్తిగత పరిశుభ్రతతో పాటు వారి పరిసరాలను పరిశుభ్రంగా ఉంచుకోవాలని కలెక్టర్ పంచాయతీ రాజ్ అధికారులు సూచిస్తున్నారు.

ఎమ్మెల్యేల వేటిలో.. నమూనా ఐక్యరాజ్యసమితి సదస్సు

దుండగల్, సెప్టెంబర్ 24 (నమస్తే తెలంగాణ) : నగరశివారు దుండగల్ గ్రామ పరిధిలోని మర్రి లక్ష్మణేశ్వరీ ఇనిస్టిట్యూట్ ఆఫ్ డిస్కాల్జిటో మొదల యూనివర్సిటీ సీఎస్ ఆస్పెక్టివ్ షర్ (నమూనా ఐక్యరాజ్య సమితి) సదస్సు అధివారం నిర్వహించారు. విద్యార్థుల్లో దాగిన ఉన్న స్వజ్ఞాపాత్రతను వెలికితీయడంతో పాటు జాతీయ, అంతర్జాతీయ సమస్యలపై అవగాహన కల్పించే వారిలో ఆత్మవిశ్వాసం పెంపొందించే క్రమంలో లీడర్లుగా తయారు చేయడమే ముఖ్య ఉద్దేశ్యం. సదస్సులను నిర్వహిస్తున్నట్లు కళాశాల కార్యదర్శి మర్రి రాజేశ్వర రెడ్డి తెలిపారు. ఈ సదస్సులో బేత, విదేశాల నుండి విద్యార్థులు పాల్గొన్నారు. ఈ సందర్భంగా పలు అంతర్జాతీయ స్థాయి సమస్యలపై కూలంకషంగా చర్చించారు. ఆయనలు వాటి నియంత్రణ, జనరల్ అసెంబ్లీలో వ్యక్తి యొక్క స్వేచ్ఛ, వాక్ స్వాతంత్ర్యం, యుద్ధాల వల్ల సమస్యలు, నివారించే చర్యలు, అదే విధంగా ఉత్తర కొరియా దుండుడుకు వైఖరిపై సమగ్రంగా చర్చించారు.



మాట్లాడుతున్న విద్యార్థి

సీఎంఆర్ కళాశాలలో ముగిసిన ఫుట్ బాల్ టోర్నమెంట్

మేధుల్, నమస్తే తెలంగాణ : శ్రీడల్ తో సమాజంలో మంచి గర్వింపు సాధించవచ్చని తెలంగాణ ఫుట్ బాల్ అసోసియేషన్ సెలెబ్రిటీ జీవీ.పాల్వన అన్నారు. మేధుల్ మండలంలోని కండ్లకోయ సీఎంఆర్ ఇంజనీరింగ్ కళాశాలలో మూడు రోజుల పాటు నిర్వహించిన 4వ తెలంగాణ రాష్ట్ర ఇంటర్ ఇంజనీరింగ్ కళాశాల ఫుట్ బాల్ టోర్నమెంట్ ముగింపు వేడుకలు అధివారం నిర్వహించారు. ఈ కార్యక్రమానికి విచ్చేసిన ఆయన మాట్లాడుతూ ప్రతి విద్యార్థి శ్రీడల్ పాటు చదువుకు తనకు సద్దిన శ్రీడల్లో రాజీనామాను సాధించారు. ఫుట్ బాల్ శ్రీడల్ దేశంలో మంచి గర్వింపు ఉందని, ఈ శ్రీడల్ రాజీనామా, అంతర్జాతీయ స్థాయిలో అదే అవకాశం లభిస్తుందని చెప్పారు. ప్రభుత్వాలు కూడ ఈ శ్రీడల్ పోత్సహిస్తున్నాయని అన్నారు. కాగా 28 జట్లు పాల్గొన్న ఈ టోర్నమెంట్ లో ఎంపీఆర్ ఇంటర్ జట్టు విజయం సాధించగా సీఎంఆర్ ఇంటర్ జట్టు రన్నర్స్ గా నిలిచింది. గెలుపొందిన విజేతలకు కమెస్ అందజేశారు. ఈ కార్యక్రమంలో కళాశాల ప్రెసిడెంట్ జంగారెడ్డి, టోర్నమెంట్ ఆర్గనైజింగ్ సెలెబ్రిటీ సయ్యద్ రజీవ్, విద్యార్థులు పాల్గొన్నారు.



ఎంపీఆర్ ఇంటర్ జట్టుకు కమెస్ అందజేస్తున్న శీవీ.పాల్వన



బతుకమ్మ అడుతున్న విద్యార్థినులు గంగిరెవ్వుల విద్యాలయం

మల్లారెడ్డి కాలేజీలో సంప్రదాయ దినోత్సవం

మేధుల్ పట్టణ పరిధి కిష్టాపూర్ లోని మల్లారెడ్డి ఇంజనీరింగ్ కళాశాలలో అధివారం సంప్రదాయ దినోత్సవం, బతుకమ్మ పండుగతో పాటు ప్రెజెంట్ డేను మనంగా నిర్వహించారు. ఈ సందర్భంగా విద్యార్థినులు సంప్రదాయ దుస్తులతో బతుకమ్మ ఆచారు. సాంస్కృతిక కార్యక్రమాలను నిర్వహించారు. గంగిరెవ్వులు, పోతురాజుల విద్యాలయాలతో సందడి చేశారు. ప్రెజెంట్ డే పురస్కారాలను గొప్ప మిస్టర్ అండ్ మిస్ ప్రెజెంట్ పోటీలను నిర్వహించారు. కార్యక్రమంలో కళాశాల చైర్మన్ వేముల మల్లారెడ్డి, కార్యదర్శి వేముల కృష్ణారెడ్డి, ప్రెసిడెంట్ డాక్టర్ శివకుమార్, ఎన్ఎస్సెస్ బృందం చేశారు.

- మేధుల్ రూరల్

PRINCIPAL
CMR COLLEGE OF ENGG & TECH
Kandlakoya (V), Medchal Hoysa
Hyderabad-501104

బుష్కర్ అండ్ మిస్ ప్రెజెంట్ అంబిక

బోనాల ఉత్సవాల్లో...

Event Report: Elite Football Cup in the month of July 2017,

- Request letter to principal to organize the Elite Football Cup through IQAC Coordinator.
- Got the approval from Principal to organize the Elite Football Cup during the month of July, and the matches were only on Saturdays.
- Circular Issued to students for the Elite Football Cup and asked for entries.
- There were 6 teams who registered for this event.
- The Draws have been taken out in the presence of 3 committee members and the captains of various teams. Draws were like this,
 - i) CSE v/s MBA winner of these two teams played with ECE, ECE team has got bye.
 - ii) In the second half EEE v/s CIVIL winner of these two played with MECH, MECH team has got bye.
 - iii) Finally the result was MECH winners and ECE runners up.
- The chief Guest for this event was Dr. M. Raji Reddy Director CMRTC.
- The Football matches conducted for boys only.
- It is very much required for students to have physical activity once in a week. Students' involvement in academics is limited to writing Mid Exams/Labs etc. in the week end there must be a recreation/any physical activity to come out with stress in the end of the week.
- And also in the week end the other students too enjoyed a lot by encouraging their department team. They also got relaxed after a week stress.
- The matches were conducted in the main grounds of CMRCET.
- The resources from the college were only play fields & playing equipment.
- 8 students from Sports Club were involved in the event they made it success, and also the faculty of various departments was present when and where their department team is playing without any disturbance the event was completed.
- Closing ceremony, Prize distribution was held on 22nd July, 2017 the chief guest for the function was Sri Ch .Gopal Reddy Chairman CMRTC.

Outcomes:

During these matches few students who are good at Foot ball game skills got selected for further training and they can be sent for college team, other university & National level

Thanking you sir



**Convener
Sports & Games Committee**

Event Photos: Elite Football Cup

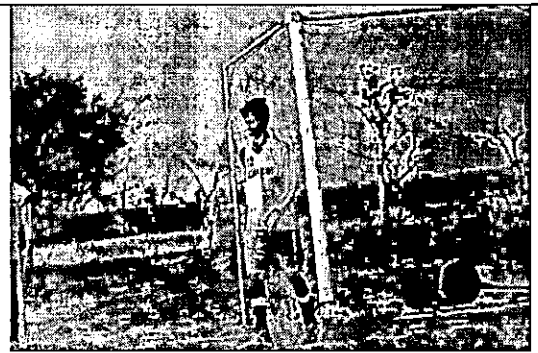

Event Report: CMRCET Volley ball Super League in the month of August 2017,

- Request letter to principal to organize the CMRCET Volley ball Super League through IQAC Coordinator.
- Got the approval from Principal to organize the CMRCET Volley ball Super League during the month of August, and the matches were only on Saturdays.
- Circular Issued to students for the CMRCET Volley ball Super League and asked for entries.
- There were 6 teams who registered for this event.
- The Draws have been taken out in the presence of 3 committee members and the captains of various teams. Draws were like this,
 - i) MECH v/s CSE winner of these two teams played with ECE, ECE team has got bye.
 - ii) In the second half EEE v/s MBA winner of these two played with CIVIL, CIVIL team has got bye.
 - iii) Finally the result was CSE winners and MBA runners up.
- The Volleyball matches conducted for boys only.
- It is very much required for students to have physical activity once in a week. The students' involvement in academics is more like MID Exam's /Labs etc. During the week end, there must be a recreation/any physical activity to have physical relaxation.
- And also in the weekend the other students too have enjoyed a lot by encouraging their department team. They also got relaxed after a week of stress.
- The matches were conducted in the Volleyball Courts of CMRCET.
- The resources from the college were only play fields & playing equipment.
- 8 students from Sports Club were involved in the event and they helped to make it successful. The faculty of various departments was also present when their department team is playing. The event was completed without any hitches.

Outcomes:

During these matches few students who are good at Volley ball game skills got selected for further training and they can be sent for college team, other university and National level

Thanking you sir



**Convener
Sports & Games Committee**

Event Photos: CMRCET Volley ball Super League

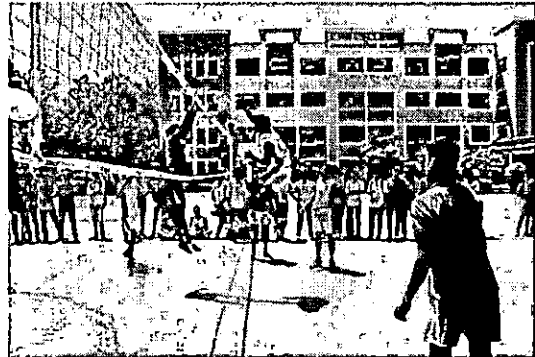
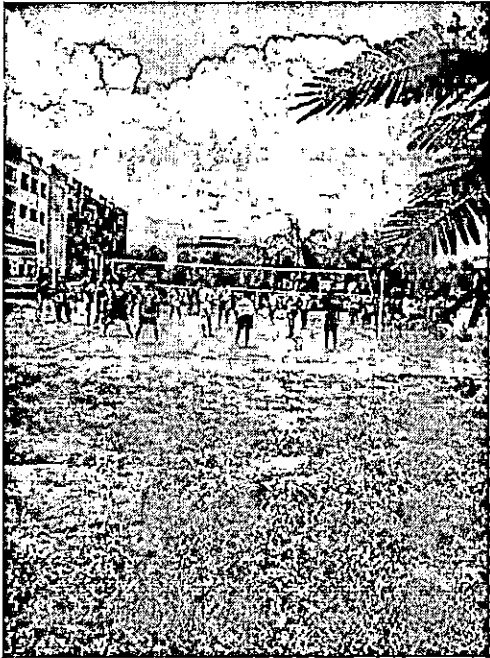
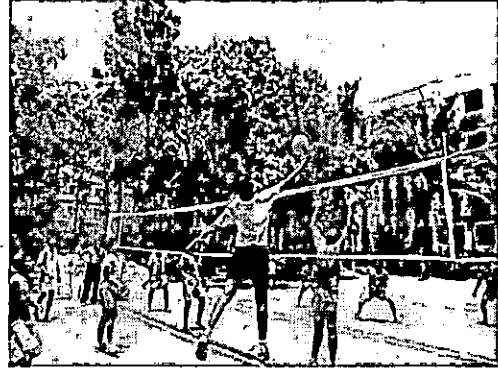
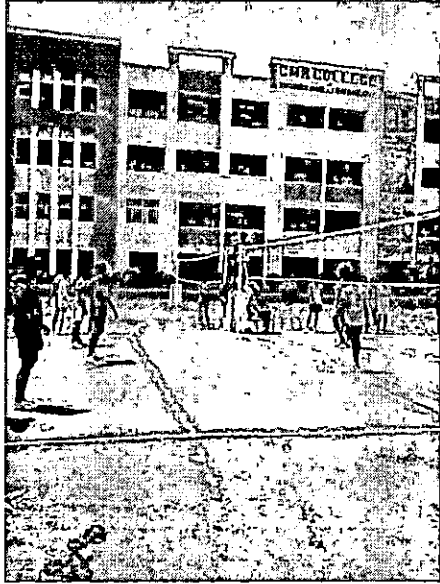

Event Report: CMR Pro Kabaddi League in the month of September 2017,

- Request letter to principal to organize the CMR Pro Kabaddi League through IQAC Coordinator.
- Got the approval from Principal to organize the CMR Pro Kabaddi League during the first two weeks of September month, and the matches were only on Saturdays.
- Circular Issued to students for the CMR Pro Kabaddi League and asked for entries.
- There were 6 teams who registered for this event.
- The Draws have been taken out in the presence of 3 committee members and the captains of various teams. Draws were like this,
 - i) EEE v/s MECH winner of these two teams played with CIVIL, CIVIL team has got bye.
 - ii) In the second half ECE v/s CSE winner of these two played with MBA, MBA team has got bye.
 - iii) Finally the result was ECE winners and CIVIL runners up.
- It is very much required for students to have physical activity once in a week. The students' involvement in academics is more like Mid Exam's /Labs etc. During the week end there must be a recreation/any physical activity to overcome the stress.
- And also in the weekend the other students have enjoyed a lot by encouraging their department team. They also got relaxed after a week full of stress.
- The matches were conducted in the Kabaddi Court of CMRCET
- The resources from the college were only play fields.
- 8 students from Sports Club were involved in the event they made it success, and also the faculty of various departments was present when and where their department team is playing without any disturbance the event was completed.

Outcomes:

During these matches few students who are good at Kabaddi game skills got selected for further training and they can be sent for college team, other university and National level

Thanking you sir



Convener
Sports & Games Committee

Event Photos: CMR Pro Kabaddi League

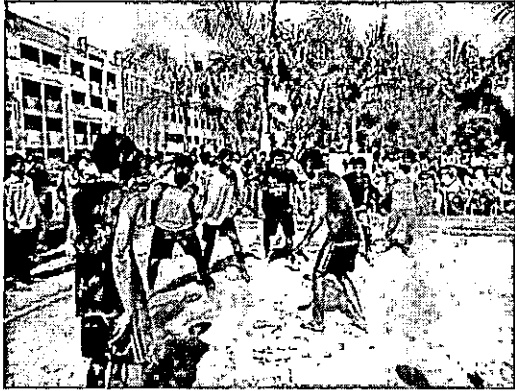

Event Report: 4th Telangana State Inter Engineering Collegiate Football Tournament in the month September 2017,

- Request letter to principal to organize 4th Telangana State Inter Engineering Collegiate Football Tournament – 2017 through IQAC Coordinator. Got the approval from Principal to organize the Tournament from 22nd to 24th September 2017.
- Invitation issued to various Engineering colleges of Telangana asking them for entries. Last date of entries was 18th September 2017.
- There were 35 teams who registered for the tournament.
- The Draws have been taken out in the presence of all the officials, Physical Director and Captains of various colleges.
- The chief guest for the inaugural ceremony was Sri Ch. Malla Reddy, Member of Parliament.
- Finally the result was Indian institute of information and technology winner & Malla Reddy Engineering college was Runnerup.
- The matches were conducted in the Main Grounds of CMR College of Engineering & Technology
- Resource persons Referees from Telangana Football Association for smooth conduction of the tournament were invited.
- 10 students from Sports Club & 3 students from photography club were involved in the tournament and they made it grand success, and also the sports committee members of our college were present for this tournament.
- Closing ceremony, Prize distribution was held on 24th September 2017, the chief guest for the function was Shri. Ch. Gopal Reddy , Secretary & Correspondent, CMRGI
- The budget sanctioned for the tournament was Rs. 1,57,400/- and the expenditure for the tournament was Rs. 1,68,449/- . The account has been settled immediately after the tournament.

Thanking you sir



**Convener
Sports & Games Committee**

Event Photos: 4th TSIEC Football Tournament.



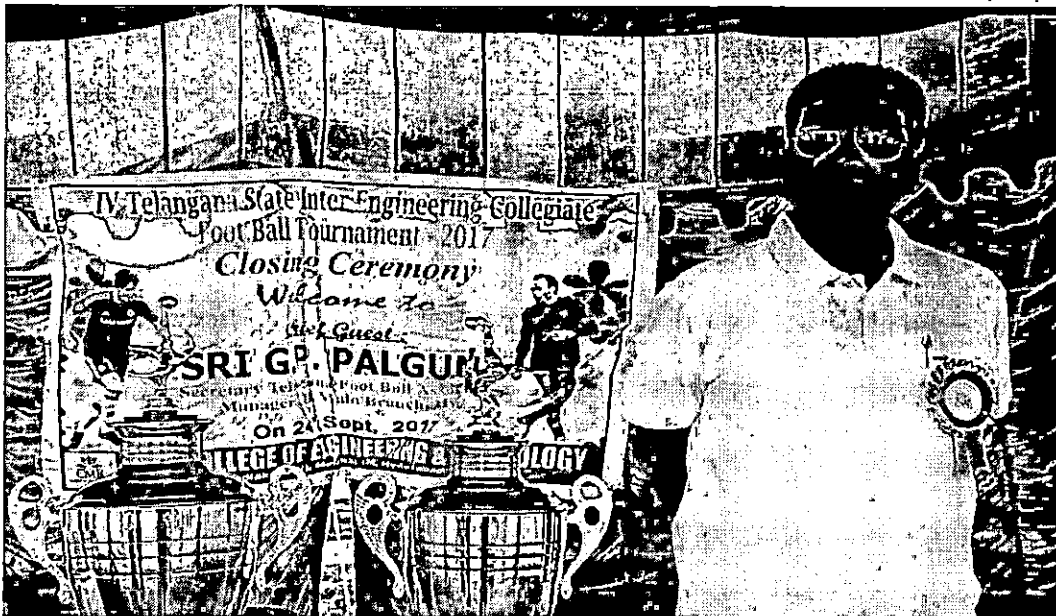

Event Report: Engineer's Throw Ball & Indoor Games Tournament in the month of October 2017

- Request letter to the principal to organize the Engineer's Throw Ball & Indoor Games Tournament through IQAC Coordinator.
- Got the approval from Principal to organize the Engineer's Throw Ball & Indoor Games Tournament during all Saturdays in the month of October.
- Circular issued to students for Engineer's Throw Ball & Indoor Games Tournament and asked for entries.
- There were 6 teams who registered for Throwball event.
- There were 4 players from each department who registered for respective Indoor games.
- The Draws have been taken out in the presence of 3 committee members and the captains of various teams. Draws were like this,
 - i) CSE v/s MBA winner of these two teams played with CIVIL, CIVIL team has got bye.
 - ii) In the second half ECE v/s EEE winner of these two played with MECH, MECH team has got bye.
 - iii) Finally the result was MECH winners and CSE runners up.
- The Throw ball matches conducted for Girls only.
- It is very much required for students to have physical activity once in a week. The students' involvement in academics is limited to writing Mid Exam /Labs etc. During the week end there must be a recreation/any physical activity to overcome the stress at the end of the week.
- And also in the weekend the other students have enjoyed a lot by encouraging their department team. They also got relaxed after a week full of stress.
- The matches were conducted in the Throw ball Court, Indoor at Indoor complex of CMRCET
- The resources from the college were only play fields & playing Equipment.
- 8 students from Sports Club were involved in the event they made it success. The faculty of various departments was present when their department team is playing. The event was completed without any incident.

Outcomes:

During these matches few students who are good at Throwball & Indoor game skills got selected for further training and they can be sent for college team to play at other university & National level

Thanking you sir



Convener
Sports & Games Committee

Event Photos: Engineer's Throw Ball & Indoor Games Tournament



Event Report: Engineering Cricket & Basket ball League in the month of December 2017,

- Request letter to principal to organize the Cricket and Basket ball events through IQAC Coordinator.
- Got the approval from Principal to organize the Cricket and Basket ball event during the month of January on Saturdays.
- Circular issued to students for the Cricket and Basket ball event and asked for entries.
- There were 6 teams who registered for each event.
- The Draws have been taken out in the presence of 5 committee members and the captains of various teams. Finally the result was CSE winners & CIVIL runners up in Cricket & ECE Winners & CSE runners in Basket ball.
- It is very much required for students to have physical activity once in a week, students involvement in academics is limited to writing MID Exam /Labs etc. in the week end there must be a recreation/any physical activity to come out of the stress in the end of the week.
- And also in the weekend the other students have enjoyed a lot by encouraging their department team. They also got relaxed after a week of stressful activity.
- The matches were conducted in the CMRCET Play Grounds.
- The resources from the college were only play fields & Playing Equipments.
- 8 students from Sports Club were involved in the event they made it success, and also the faculty of various departments was present when and where their department team is playing without any disturbance the event was completed.

Outcomes:

During these matches few students who are good at Cricket and Basket ball game skills got selected for further training & they can be sent for college team, other university & National level

Thanking you sir

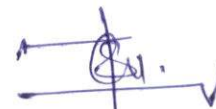

Convener
Sports & Games Committee

Event Photos: Engineering Cricket & Basket ball League

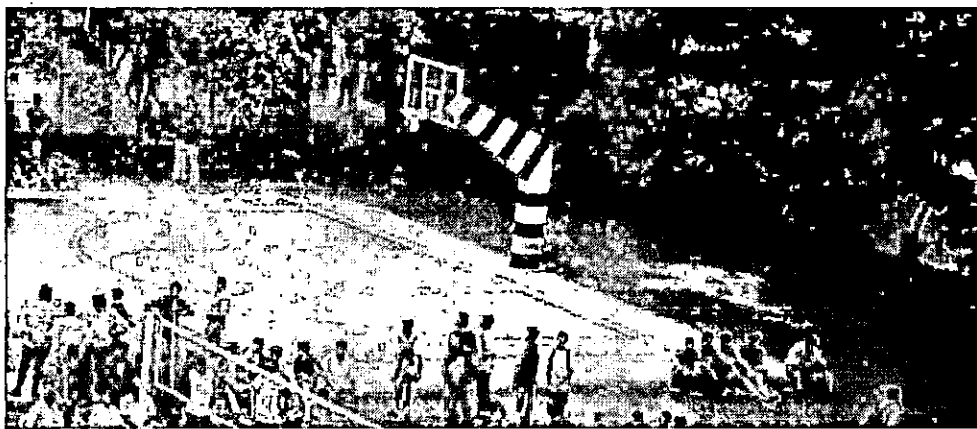
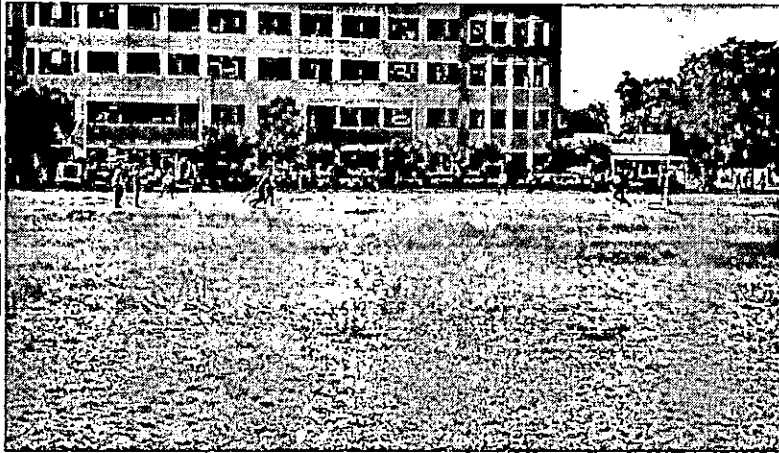

Event Report: Hidden Talent Search in Freshers 2018 in the month of January 2018,

- Request letter to the principal to organize the Hidden Talent Search in Freshers 2018 through IQAC Coordinator.
- Got the approval from Principal to organize the Hidden Talent Search in Freshers 2018 during the month of January.
- Circular issued to students for the Hidden Talent Search in Freshers 2018 and asked for entries.
- The Draws have been taken out in the presence of 3 committee members and the captains of various teams, and after the completion of matches results were declared.
- It is very much required for students to have physical activity once in a week. The Students' involvement in academics is limited to writing MID Exam's /Labs etc. During the week end there must be a recreation/any physical act.
- And also in the weekend the other students have enjoyed a lot by encouraging their department team. They also got relaxed after a week full of stress.
- The matches were conducted in CMRCET Grounds
- 8 students from Sports Club were involved in the event they made it success, and also the faculty of various departments was present when and where their department team is playing without any disturbance the event was completed.
- Prize distribution program held on Fresher's day.

Outcomes:

During these matches few students who are good at various sports & games skills got selected for further training and they can be sent for college team, other university & National level

Thanking you sir



Convener
Sports & Games Committee

Event Photos: Hidden Talent Search in Freshers 2018

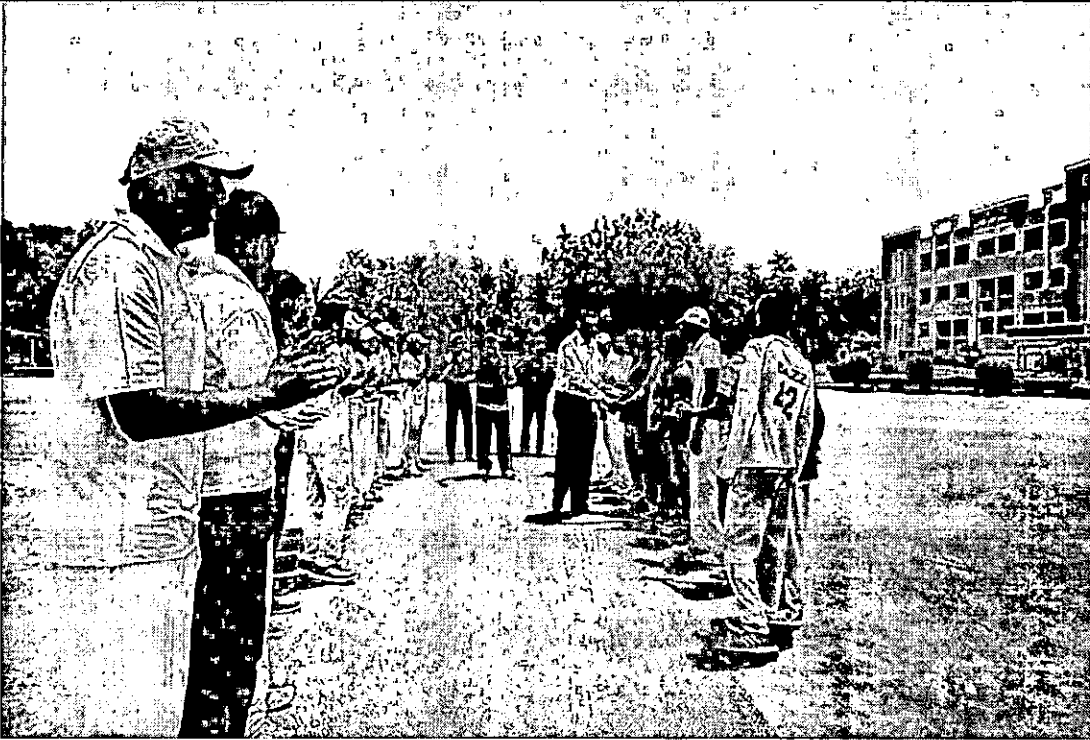
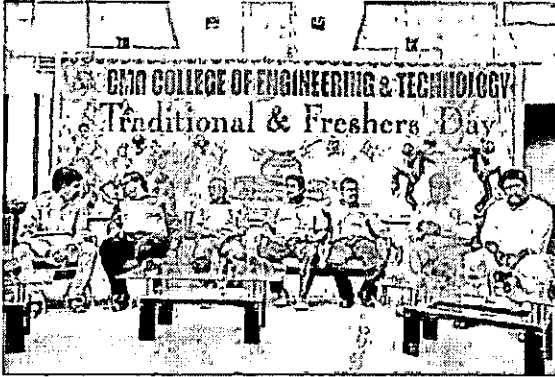

Event Report: Ultimate Kho Kho League in the month of February 2018,

- Request letter to principal to organize the Ultimate Kho Kho League through IQAC Coordinator.
- Got the approval from Principal to organize the Ultimate Kho Kho League during the month of February month on Saturdays.
- Circular issued to students for the Ultimate Kho Kho League and asked for entries.
- There were 6 teams who registered for this event.
- The Draws have been taken out in the presence of 3 committee members and the captains of various teams. Draws were like this,
 - i) CIVIL v/s MECH winner of these two teams played with ECE, ECE team has got bye.
 - ii) In the second half EEE v/s MBA winner of these two played with CSE, CSE team has got bye.
 - iii) Finally the result was CSE winners and CIVIL runners up.
- It is very much required for students to have physical activity once in a week, students involvement in academics is limited to writing MID Exam's /Labs etc. At the week end there must be a recreation/any physical activity to come out of the stress.
- And also in the weekend the other students have enjoyed a lot by encouraging their department team. They too got relaxed after a week stress.
- The matches were conducted in the Kho Kho Ground of CMRCET
- The resources from the college were only play fields.
- 8 students from Sports Club were involved in the event they made it success, and also the faculty of various departments was present when and where their department team is playing without any disturbance the event was completed.

Outcomes:

During these matches few students who are good at Kho Kho game skills got selected for further training and they can be sent for college team, other university & National level

Thanking you sir

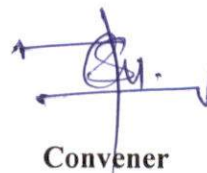

**Convener
Sports & Games Committee**

Event Photos: Ultimate Kho Kho League

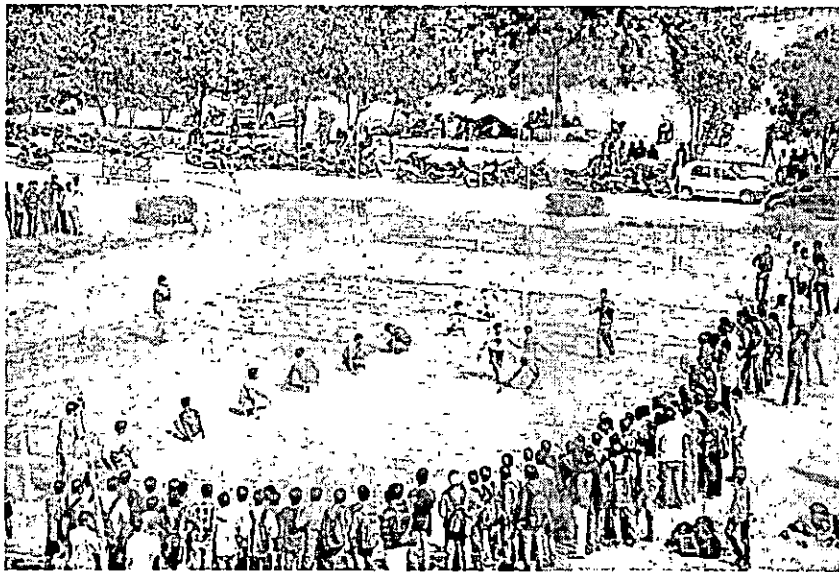
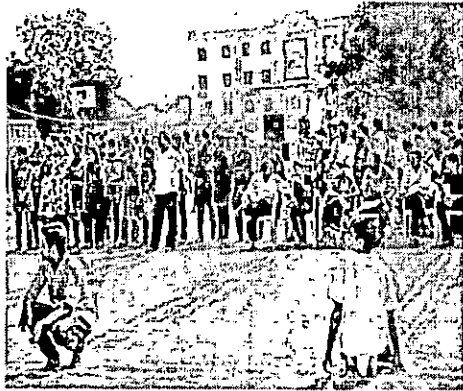

Event Report: Annual Sports day Tournaments in the month of March 2018

- Request letter to principal to organize the Annual day Sports through IQAC Coordinator.
- Got the approval from Principal to organize the Annual Sports day matches during the month of March.
- Circular issued to students for the Annual Sports day matches and asked for entries.
- The Draws have been taken out in the presence of 6 committee members and the captains of various teams, and after the completion of matches results were declared.
- The matches were conducted in CMRCET Grounds
- 10 students from Sports Club & 3 students from photography club were involved in the Annual day matches & they made it grand success, and also the sports committee members of our college were present for this event.
- Prize distribution program held on 31st March,2018 .

Outcomes:

During these matches few students who are good at various sports & games skills got selected for further training and they can be sent for college team, other university & National level

Thanking you sir



Convener
Sports & Games Committee

Event Photos: Annual Sports day Tournaments

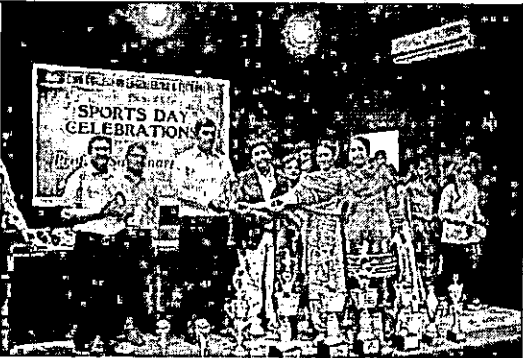
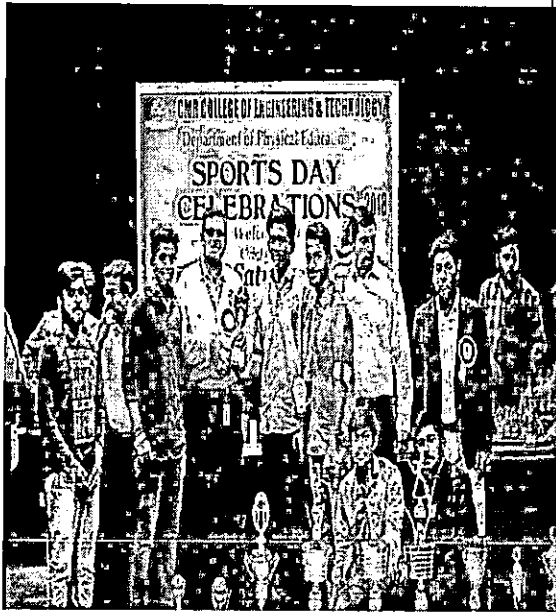

Event Report: JNTUH Zone 'C' and Central Zone Inter Engineering Collegiate Football Tournament in the month of March 2018,

- Request letter to principal to organize JNTUH Zone 'C' and Central Zone Inter Engineering Collegiate Football Tournament – 2018 through IQAC Coordinator. Got the approval from Principal to organize the Tournament from 24th to 27th March 2018.
- Invitation issued to various Engineering colleges of JNTUH Zone 'C' asking them for entries. Last date of entries was 20th March, 2018.
- There were 26 teams who registered for the tournament.
- The Draws have been taken out in the presence of all the officials, Physical Director and Captains of various colleges.
- The chief guest for the inaugural ceremony was Sri Ch. Malla Reddy, Member of Parliament.
- The Guest of Honour for the inaugural ceremony was Sri M. Yedukondalu, Former International Football player.
- Finally the Zone 'C' result was CMR College of Engineering and technology winner & St. Martins Engineering college was Runner up.
- And the Central Zone Winners are St.Martins Engineering College, Runners CMR College of Engineering and Technology.
- The matches were conducted in the Main Grounds of CMR College of Engineering & Technology
- Resource persons Referees from Telangana Football Association for smooth conduction of the tournament were invited.
- 10 students from Sports Club & 3 students from photography club were involved in The tournament and they made it grand success, and also the sports committee members of our college were present for this tournament.
- Closing ceremony, Prize distribution was held on 27th March, 2018, the chief guest for the function was Shri. Ch. Gopal Reddy , Secretary & Correspondent, CMRGI
- The budget sanctioned for the tournament was Rs. 1,18,500/- and the expenditure for the tournament was Rs. 1,16,206/- . The account has been settled immediately after the tournament.

Thanking you sir

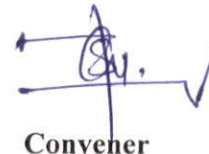

Convener
Sports & Games Committee

Event Photos: JNTUH Zone 'C' and Central Zone Football Tournament



